

MERCURY
RACING

STERNDRIVES



WIDE OPEN

IN A WORLD OF LIMITS, CHOOSE FREEDOM

Mercury Racing is committed to the pursuit of Wide Open. More than a function of throttle position, Wide Open is an expression of our core philosophy. We recognize no boundaries and accept no compromise. Where others perceive a barrier, we see an opportunity. We create premium high-performance marine power to take you faster and farther. We give you control to shatter expectations. The world offers limits. Mercury Racing offers freedom.

QC4	13
DUAL CAL 1550/1350	22
DUAL CAL 1350/1150	22
1100	23
860	27
SCI	31
700	40
600	41
NATURALLY ASPIRATED	43
565	48
520	49
DRIVES	51
PROPELLERS	55
ACCESSORIES	58
QC4 REFRESH	59





MASTERS OF SPEED

Aluminum and steel. Oil and fuel. These are the raw elements of extreme performance. In the skilled hands of a Mercury Racing master technician, those elements are transformed into the most extraordinary engines on the water. Amazing power is delivered with turn-key reliability. Decades of experience, the lessons learned in the shop and on the water, are built into each Mercury Racing sterndrive. Our precision and practices are ISO certified. Our expertise is unmatched. Our passion is genuine.

EVERY MERCURY RACING PRODUCT IS IMBUED WITH THE SKILLS AND IDEALISM OF THE PEOPLE WHO CREATED IT.



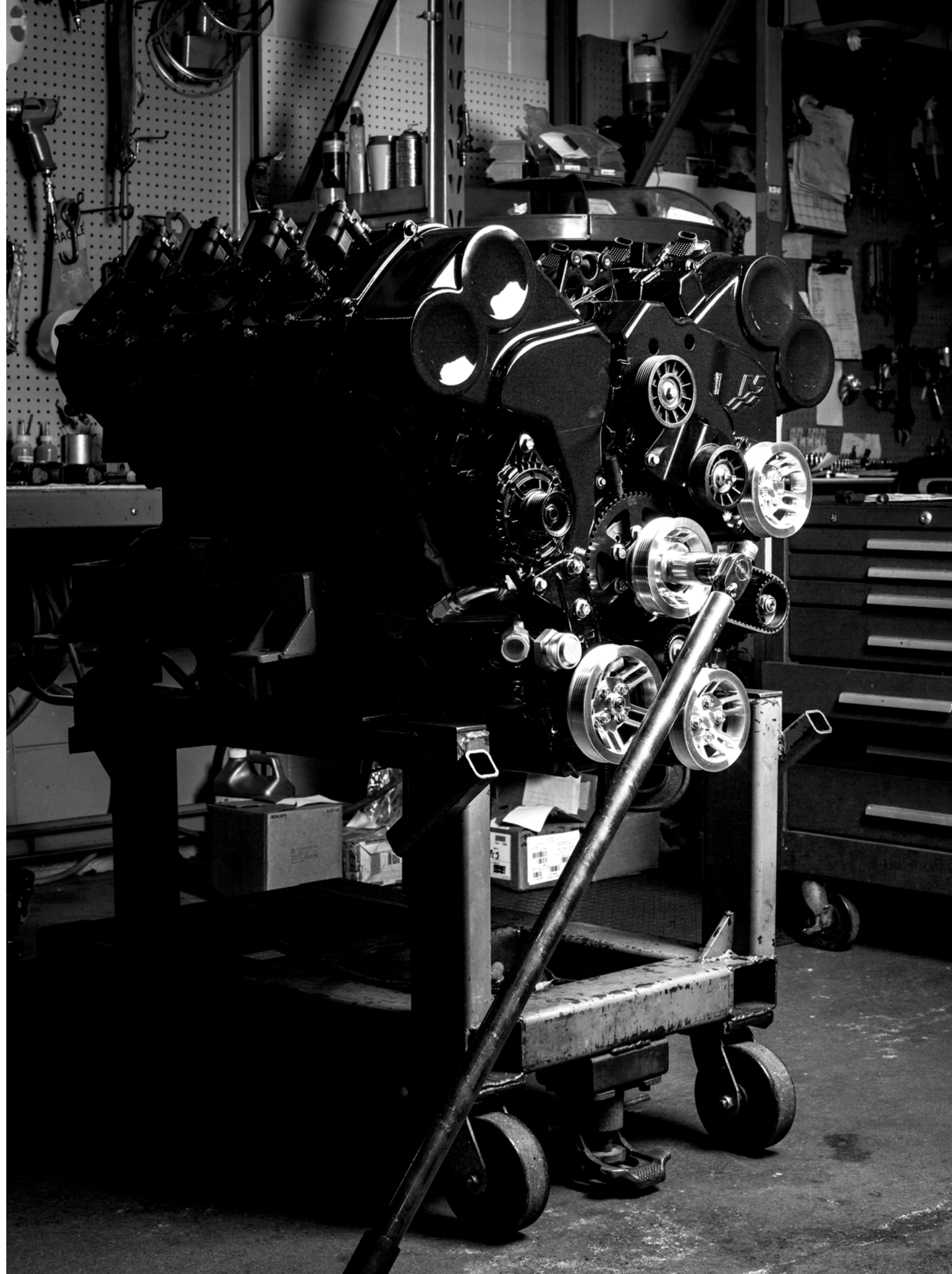

WE THINK BIG

Big ideas are digitized and fine-tuned using the latest CAD and CFD tools. Digital data is transformed to metal and real-world testing begins in our dyno room and on the water at Lake X, our private test facility. We pursue not just power and speed, but precision and craftsmanship.

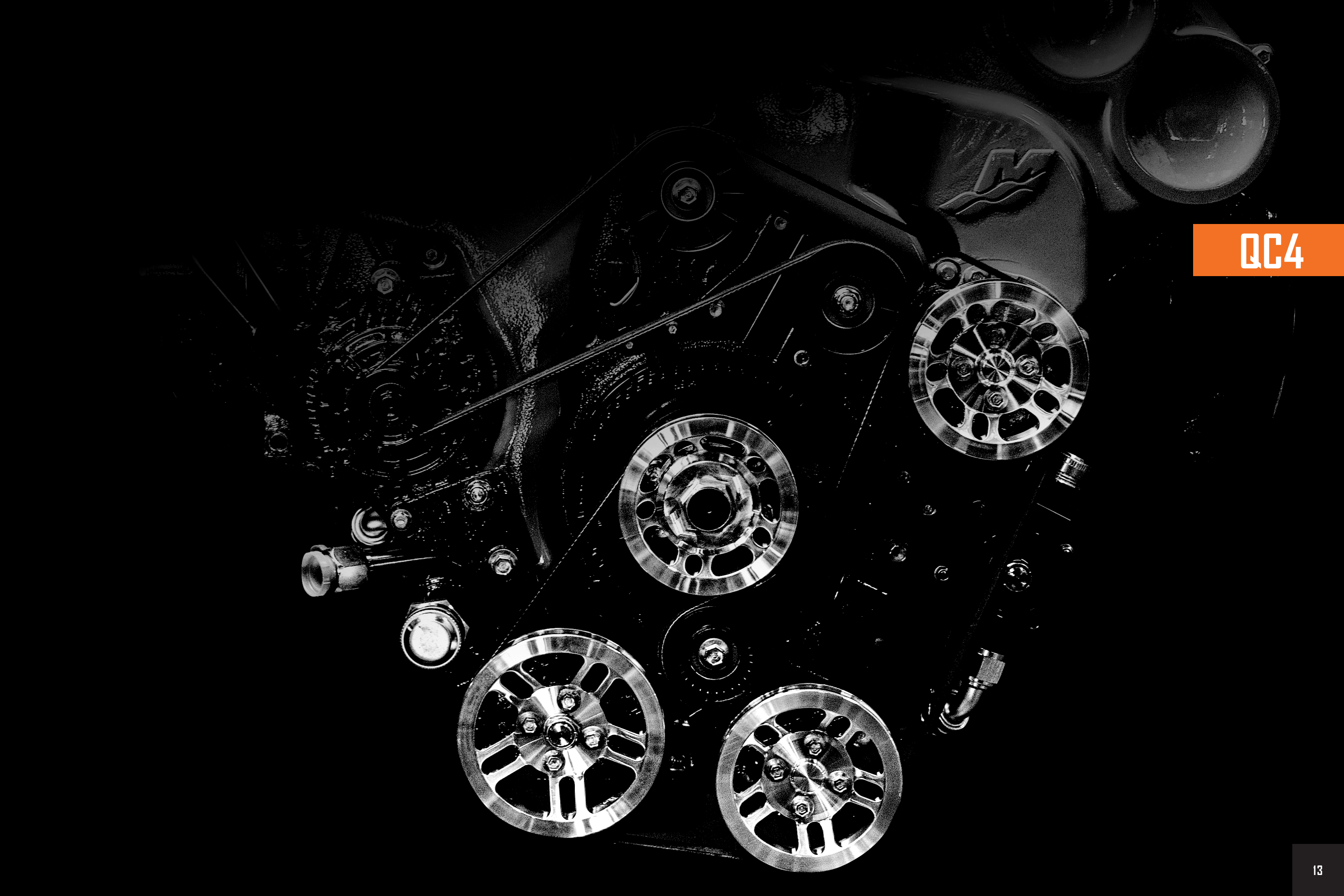

QC4

ABSOLUTELY UNRELENTING PERFORMANCE

This is the pinnacle of Mercury Racing performance, created for owners with an unquenchable desire for acceleration and speed. Nine liters of sophisticated power custom-designed by Mercury Racing specifically to propel the fastest pleasure boats on the water.





BREAK BARRIERS

9.0 LITERS / DOHC

Here's a benchmark for marine engine performance: 150 horsepower per liter of displacement on pump gasoline. To break through that barrier, Mercury Racing designed the QuadCam 4-Valve – QC4 – engine family. That's four overhead camshafts and four valves per cylinder on top of nine robust liters of V8 displacement.

Sophisticated engine management. Premium components. These deep-breathing, high-revving, power-dense engines are part of a complete high-performance system – engine, transmission, drive, propeller and controls engineered and tested together for the ultimate in premium performance and absolute reliability.



POWER DENSITY

CUSTOM BLOCK / PREMIUM COMPONENTS

This custom Mercury Racing V8 aluminum engine block is designed to be as lightweight and compact as possible. Bore and stroke were selected to achieve optimal torque and high-revving horsepower. Nikasil®-coated cylinders promote efficient heat transfer. We gave it a deep skirt to keep the bottom end rigid, and support the crankshaft with 6-bolt main bearings. Premium engine components include a Calles crankshaft, König® pistons, and Manley® connecting rods. The result is 9 liters of reliable, race-proven performance.

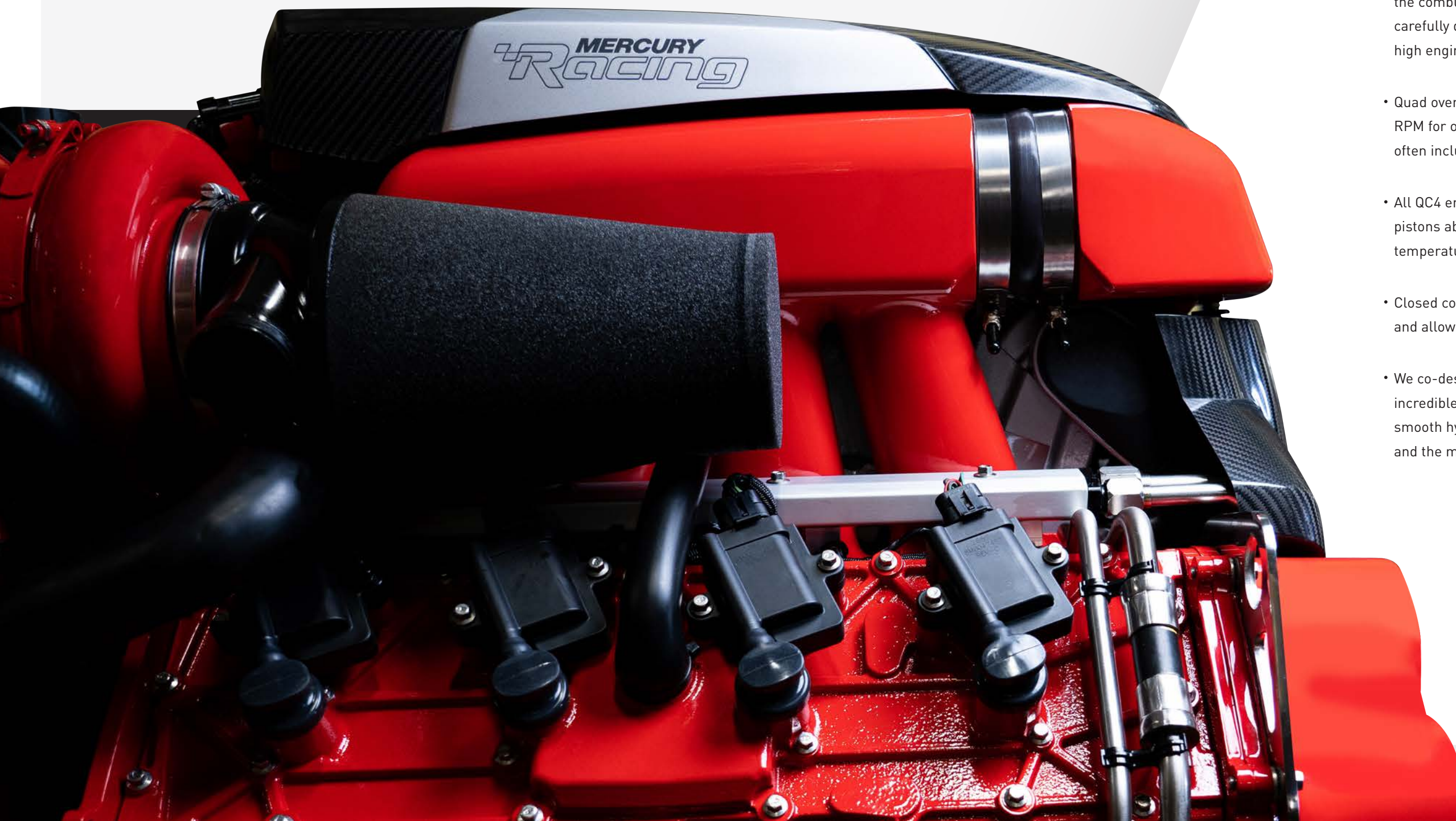

DEEP BREATHER

4 CAMS / 32 VALVES

- Our four-valve heads optimize intake and exhaust flow through the combustion chamber. More flow means more power, and carefully designed turbulence ensures complete combustion at high engine RPM.
- Quad overhead cams lower valvetrain system stress at high RPM for outstanding durability in an extreme duty cycle that often includes extended full-throttle run time.
- All QC4 engines are assembled with high-performance forged pistons able to withstand extreme cylinder pressure and high temperatures.
- Closed cooling protects the engine from corrosive salt water and allows more-precise control of engine temperature.
- We co-designed a transmission with Velvet Drive to match the incredible power of each QC4 engine. Compact yet robust, the smooth hydraulic-shifting transmission can handle QC4 torque and the most-demanding duty cycle in powersports.

1550/1350

DUAL CAL

1350/1100

DUAL CAL

1100

TURBO CHARGED EXCITEMENT

Air flow equals horsepower. To maximize QC4 performance, we forced the issue. Forced-air induction provided by twin turbochargers extracts incredible performance while minimizing parasitic power loss. Our carefully engineered system features pulse-separated exhaust manifolds that drive high-velocity gas flow to limit turbo lag for instant throttle response. An electronic waste gate maintains precise boost control. A charge-air cooler removes heat created by turbo compression to create a dense, power-rich intake charge. The rush of on-demand turbocharged acceleration is absolutely mind-blowing.

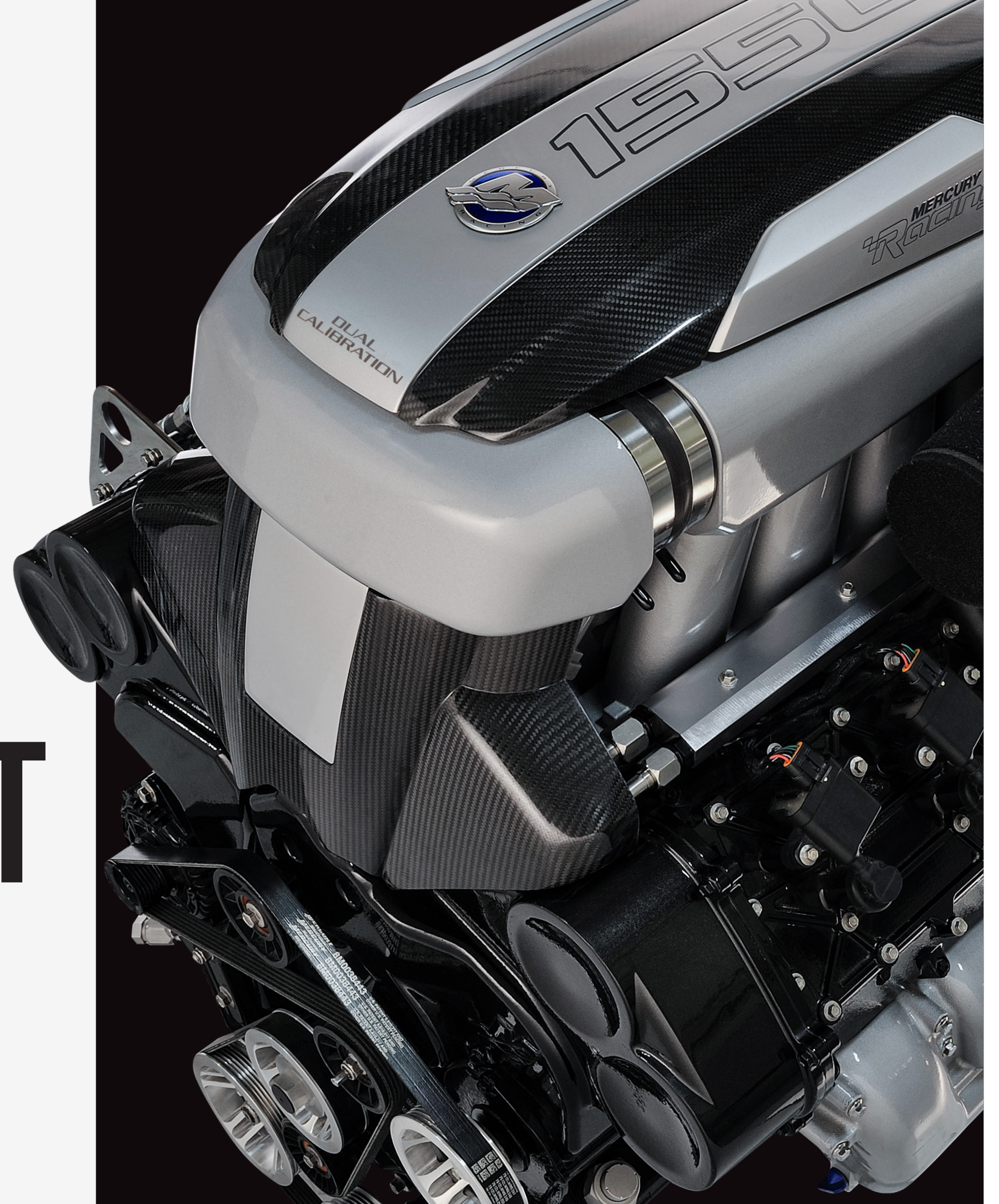

1550/1350 ■ 1350/1100 ■ 1100

DUAL CAL 1550/1350

COMP PISTONS / HIGH RPM

Maximum power for the biggest, fastest performance boats and the owner who demands nothing less than unrivaled acceleration and speed. Experience race-bred performance and 1550hp on 112 AKI fuel or an alternate calibration offering 1350hp on 91 octane (98 RON) pump fuel. Full-throttle RPM increases to 6200-6800 in 1550hp calibration for maximum boat speed without a prop change. Pistons forged from a special competition-spec alloy handle the heat generated by the 1550hp calibration.



DUAL CAL 1350/1100

PUMP FUEL / DUAL CALIBRATION

Precise engine control enables incredible power on readily-available pump fuel. Thrill to the full performance potential of 1350hp on 91 octane (98 RON) fuel, or switch to the 1100hp calibration and reduce the octane requirement to 89 or REC 90 when premium fuel is not available. A broad wide-open throttle RPM range facilitates propping options to optimize performance by boat type, size and weight.

THE DUAL CAL FOB

SELECTABLE POWER / ANTI-THEFT

Mercury Racing Dual Cal (dual calibration) engines feature an advanced control system which enables the operator to switch engine power level via an electronic key fob. Plug in one fob for maximum power, or the second for less power on lower octane fuel. A single fob controls the power output of all engines on the boat. The fobs are tied to the Mercury Theft Deterrent System (TDS). When a fob is not engaged the vessel is disabled.



1100

TURBO RUSH / DRIVE OPTIONS / 2 YEAR WARRANTY

The thrust of 1,100 lb. ft of torque across the mid-range produces amazing acceleration that will leave the fleet in your spray. Maximum power is always available on 89 posted octane pump fuel so you can cruise without fuel anxiety. Ultra-responsive to throttle input from smooth-and-precise Mercury Racing Digital Zero Effort controls. Compatible with the legendary Mercury Racing M6 drive or the Mercury Racing M8 drive for optimal rigging flexibility.

COLOR OPTIONS



DUAL CAL SPECS 1550/1350 1350/1100

HORSEPOWER AT TRANSOM	1550/1350	1350/1100
FULL THROTTLE RPM	6200-6800 (1550 HP) 6000-6500 (1350 HP)	6000-6500
DISPLACEMENT	9.0L/552 CID	9.0L/552 CID
BORE & STROKE	4.57 x 4.21 IN / 116 x 107 MM	4.57 x 4.21 IN / 116 x 107 MM
CYLINDERS/ENGINE CONFIG	V8	V8
ALTERNATOR	105 AMP	105 AMP
FUEL REQUIREMENT	112 AKI Required for 1550 Calibration/ 91 Octane (98 RON) for 1350 HP	91 Octane For 1350 HP Calibration / 89 Octane 1100 HP Calibration
FUEL SYSTEM	Sequential Fuel Injection	Sequential Fuel Injection
GEAR RATIO	Application Dependent	Application Dependent
WARRANTY	10 Hour Warranty At The 1550 Power Level (At 2000 RPM Or Above) Or 1 Year, Whichever Comes First.	1-Year Limited Warranty
CONTROLLER	PCM09	PCM09
TRANSMISSION	Mercury Racing Dry-Sump Hydraulic	Mercury Racing Dry-Sump Hydraulic
DRIVE UNIT	M8	M8
LENGTH-FROM BACK OF BLOCK ¹	31"	31"
WIDTH	35"	35"
HEIGHT	29"	29"

¹Includes transmission

QC4 SPECS 1100

HORSEPOWER AT TRANSOM	1100
FULL THROTTLE RPM	6000-6500
DISPLACEMENT	9.0L/552 CID
BORE & STROKE	4.57 x 4.21 IN / 116 x 107 MM
CYLINDERS/ENGINE CONFIG	V8
ALTERNATOR	105 AMP
FUEL REQUIREMENT	89 Octane (R + M)/2, (95 RON)
FUEL SYSTEM	Sequential Fuel Injection
GEAR RATIO	Application Dependent
WARRANTY	2-Year Limited
CONTROLLER	PCM09
TRANSMISSION	Mercury Racing Dry-Sump Hydraulic
DRIVE UNIT	M6 / M8
LENGTH-FROM BACK OF BLOCK ¹	26.69"
WIDTH	34"
HEIGHT	29"

¹Includes transmission

860

REVS SKY HIGH

Only Mercury Racing could offer performance boaters 860 naturally aspirated horsepower and 6800 peak RPM on 89 octane (REC 90) pump gasoline, and back this amazing engine with a two-year limited warranty. The QC4 heads and efficient intake tract flow a high volume of air for outstanding torque delivery and up to 6800 RPM for unsurpassed acceleration and propeller options to optimize boat performance. Catch your breath, before the Mercury Racing QC4 860 takes it away.



RAM HORN INTAKE / DUAL THROTTLE BODIES

Twin 92mm electronic throttle bodies feed intake runners designed to optimize torque and acceleration. Rear-facing ram horn intakes direct induction noise aft to reduce cockpit sound levels, enhance engine power and permit tighter installation of staggered engines due to enhanced exhaust routing.

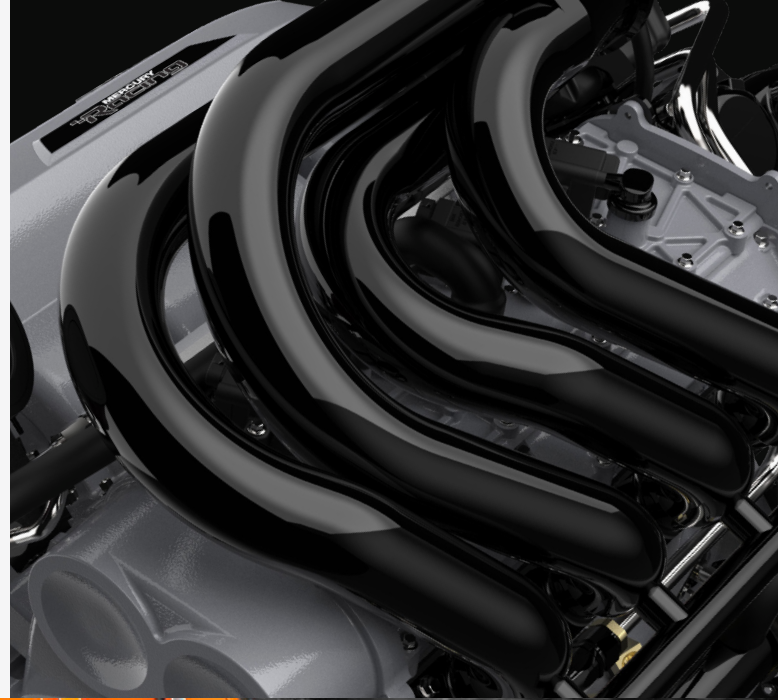

CUSTOM CAMS / HEAT EXCHANGER

Exclusive high-lift camshaft profiles combined with high-velocity cylinder head intake ports enhance air flow to the combustion chamber. Pistons designed specifically for the QC4 860 engine achieve a 9.75:1 compression ratio to maximize torque. A race-proven heat exchanger provides a generous sea water flow rate for enhanced cooling of engine oil and coolant.



COMPACT TRANSMISSION

Mercury Racing designed a hydraulic transmission specifically for the QC4 860 engine. The compact design minimizes overall powertrain length in both drive-line and close couple installations. Its rugged design can handle high torque and power levels, and endure demanding offshore duty cycles.

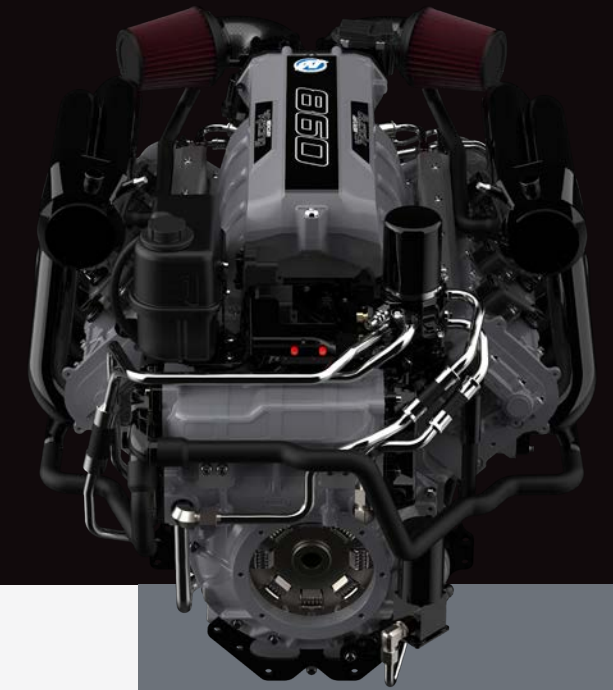

860 SPECS

HORSEPOWER AT TRANSOM	860
FULL THROTTLE RPM	6300-6800
DISPLACEMENT	9.0 L
BORE & STROKE	4.57 x 4.21 IN/116 x 107 MM
CYLINDERS/ ENGINE CONFIG	V8
ALTERNATOR	95 AMP
FUEL REQUIREMENT	89 Octane Minimum (R + M)/2, (95 RON) Global Calibration
FUEL SYSTEM	Sequential Fuel Injection
GEAR RATIO	Application Dependent
WARRANTY	2-Year Limited
CONTROLLER	PCM09
TRANSMISSION	Mercury Racing Hydraulic
DRIVE UNIT	M6
LENGTH-FROM BACK OF BLOCK ¹	31"
WIDTH	38.3"
HEIGHT	26"

¹Includes transmission

COLOR OPTIONS





POWER FOR THE PEOPLE

Mercury Racing has been running Wide Open since 1973. Originally established as Mercury Performance Products, its small-but-passionate team promoted the Mercury brand through tunnel boat and offshore competition. In 1990 Brunswick Corporation acquired Kiekhaefer Aeromarine, bringing key products such as the Kiekhaefer competition sterndrive and Zero Effort controls into a new Mercury Racing portfolio that began a gradual expansion into consumer high-performance outboard and sterndrive engines, propellers and accessories. Today the Mercury Racing mission is to push marine power and performance in every category to the limit.

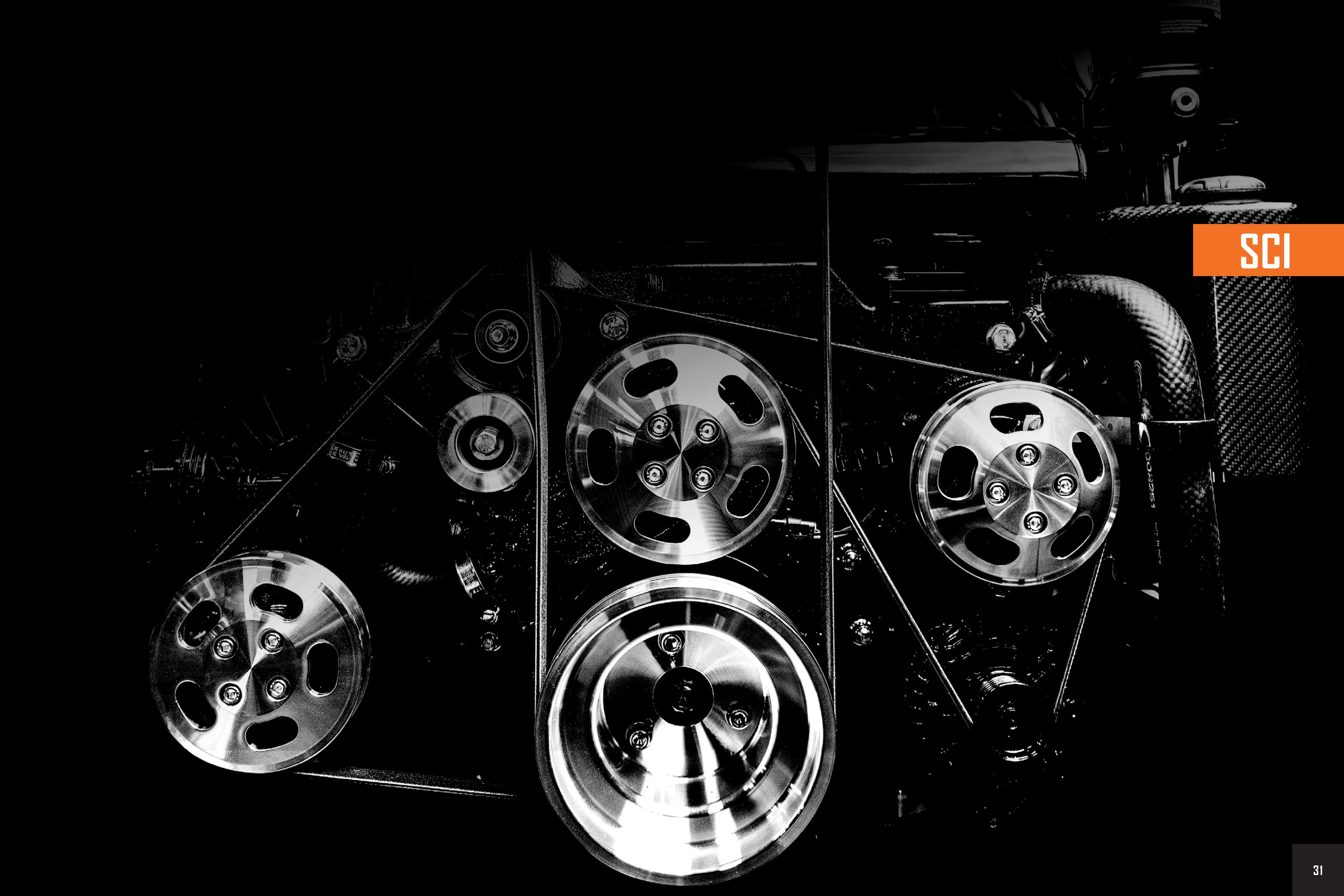

SCI

SUPER CHARGED

Feel the intoxicating thrust generated by instant, unrelenting torque across the RPM range. Mercury Racing SCi engines apply the immediate boost of supercharged induction to engines engineered for extreme marine performance by the most experienced team on the water. Prepare to be blown away.



POWER UP

POWER UP

POWER DENSITY AUTOMATIC BOOST CONTROL

Supercharging allows Mercury Racing SCi engines to achieve outstanding power density from a compact package, the ideal formula for staggered twin installations and the tight confines of some high-performance catamaran hulls. These engines optimize power and performance by self-adjusting boost pressure to changing environmental conditions and elevation, from a cold day in Michigan to the desert heat of Havasu.

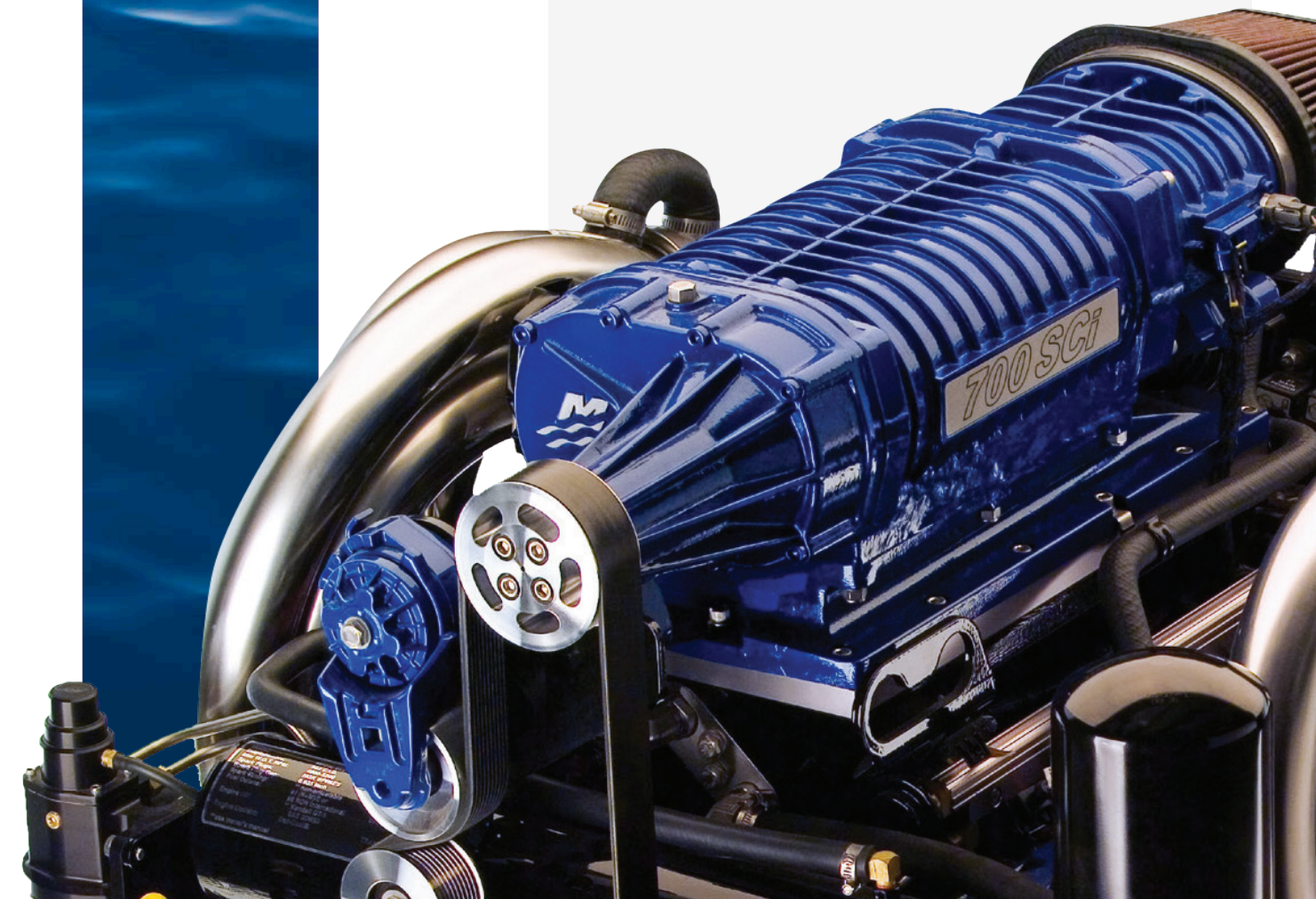



FORCE THE ISSUE

SCREW-TYPE COMPRESSOR / BOOST CONTROL

Engineered for power. A compact 3.3-liter screw-type compressor provides the most-efficient supercharging option. A sophisticated electronic boost control valve maintains consistent mass air flow – and power output – as ambient temperature and elevation changes. The rear-facing intake provides a quieter cockpit experience.

ADVANCED BIG BLOCK

ALUMINUM HEADS / 87 OCTANE / CLOSED COOLED

Durable cast iron GM Gen VI 502 CID block is custom CNC machined for Mercury Racing. Aluminum cylinder heads are custom cast to Mercury Racing specifications, and roller rocker arms enhance durability of the valve train. A powerful mechanical fuel pump feeds a high-pressure electric pump to help reduce vapor lock in extreme conditions. Full power is available on readily available 87 octane (95 RON) pump fuel. An advanced closed-cooling system features five-year coolant for reduced maintenance and increased corrosion protection. Custom polished sweeper headers are tuned to maximize power, and the headers and engine calibration are designed to accommodate the Mercury Racing X-Haust Noise Reducer muffler system.

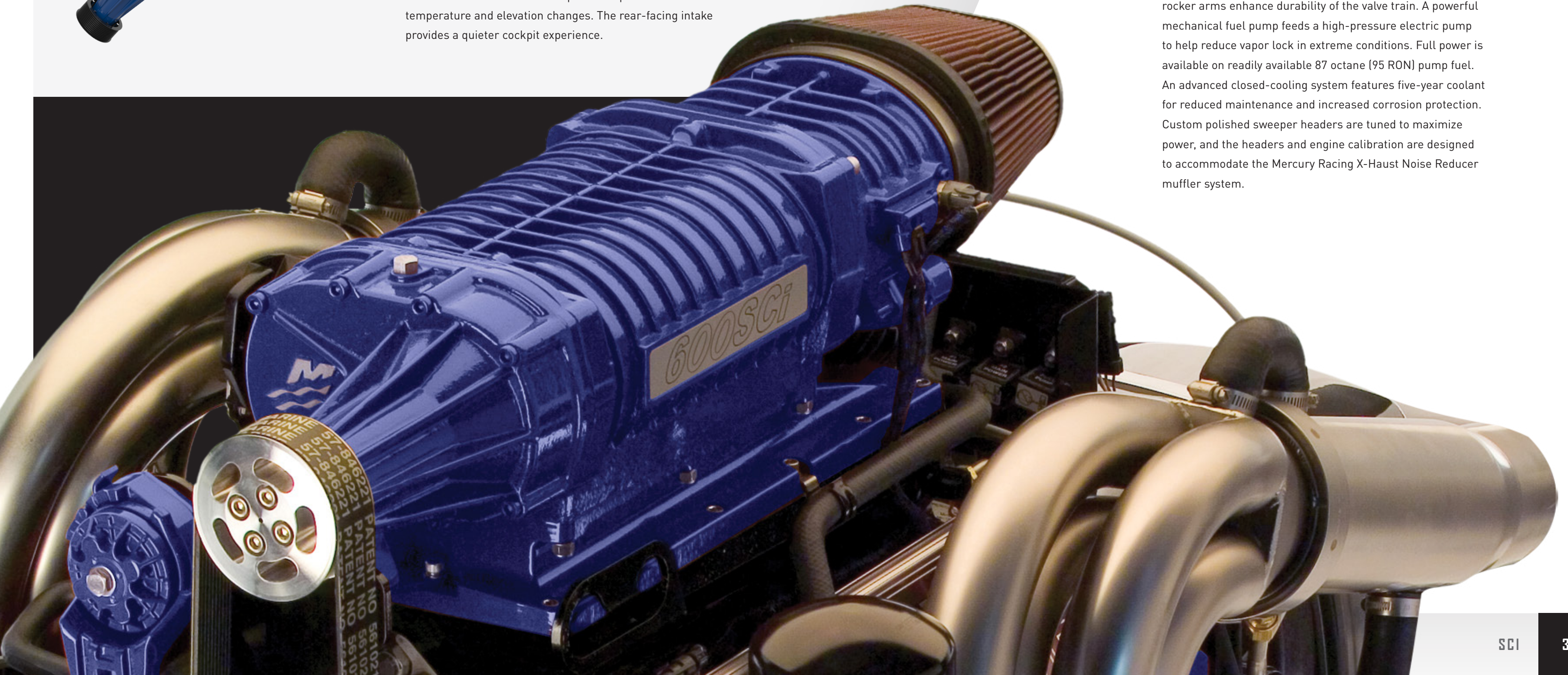

700/600 **SCI**

FORMULA FOR POWER

Nothing says hot rod like a finned and powder coated blower perched on top of an American V8 engine. Supercharging helps extract immediate, reliable power from a traditional big block engine configuration while maintaining a compact powertrain envelope. A Mercury Racing SCi engine is the perfect power prescription for many performance applications.

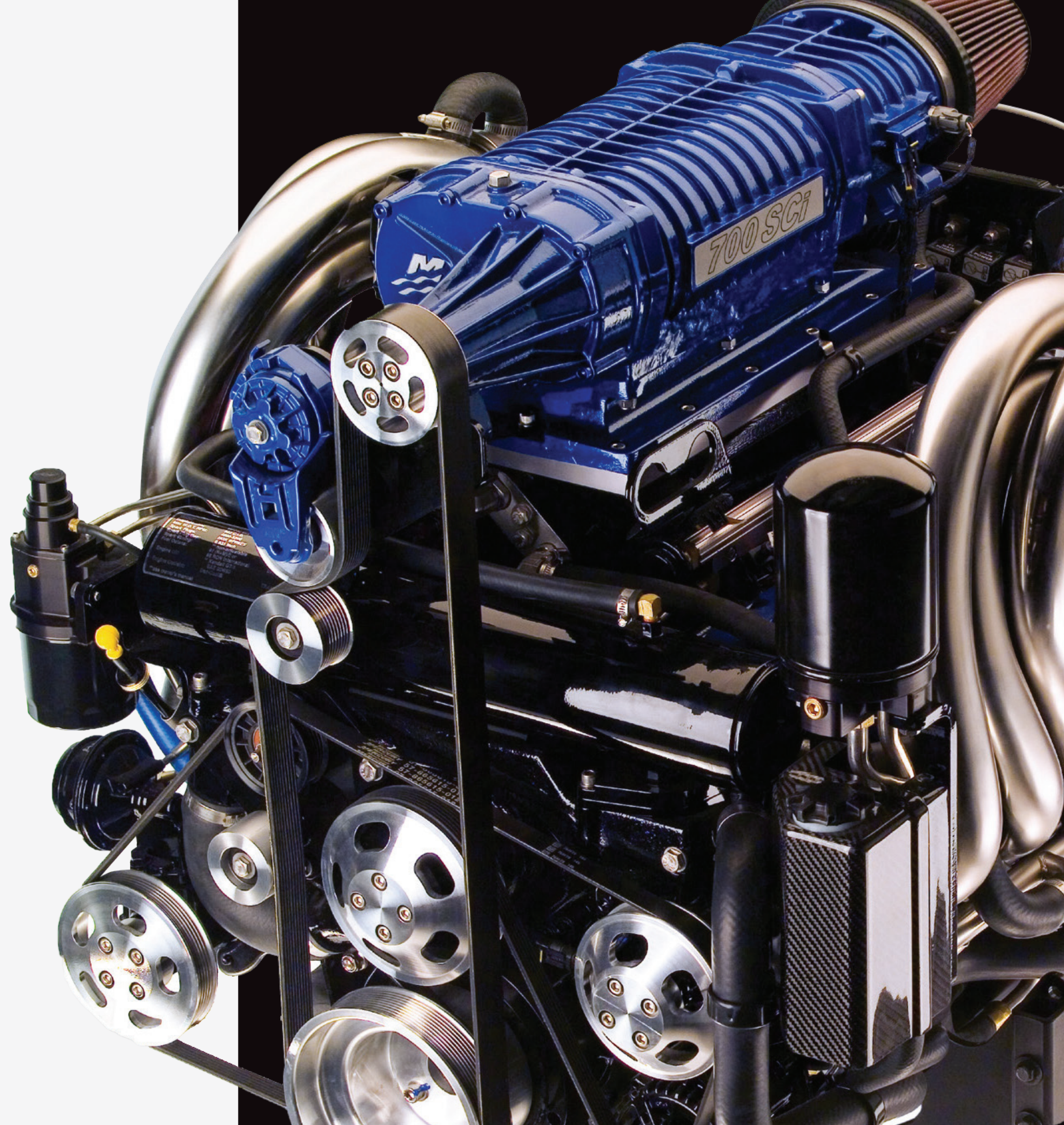

700 SCI

COMPACT TRANSMISSION / PERFORMANCE CAM

A compact and rugged transmission designed by Mercury Racing is exclusive to the 700 SCi engine and permits use of the dry sump M6 drive with the engine in the same near-transom location as a Bravo One XR® drive installation. A specific camshaft grind, a taller charge air cooler, increased supercharger boost and a custom performance calibration delivers 700 horsepower at the transom. The optional X-Haust Noise Reduction system brings the 700 SCi in compliance with most noise regulations outside of the European Union. The legendary Mercury Racing M6 drive is standard with the 700 SCi engine, with the M8 drive available for certain applications that require a lower engine installation.

700 SCI SPECS

HORSEPOWER AT TRANSOM	700
FULL THROTTLE RPM	4800-5200
DISPLACEMENT	8.2 L
BORE & STROKE	4.47 x 4.00 IN/113 x 102 MM
CYLINDERS/ENGINE CONFIG	V8
ALTERNATOR	90 AMP
FUEL REQUIREMENT	87 Posted Pump Octane (R+M/2), (95 RON) International
FUEL SYSTEM	Computer Controlled Sequential Multi-Port Electronic Fuel Injection (EFI)
GEAR RATIO	Application Dependent
WARRANTY	1-Year Limited For Recreational Boating
CONTROLLER	PCM Distributorless
TRANSMISSION	Mercury Racing Dry Sump
DRIVE UNIT	M8 or M6
LENGTH-FROM BACK OF BLOCK ¹	35.7"
WIDTH	33"
HEIGHT	27.9"

¹Includes transmission



600 SCI

COMPACT TRANSMISSION / PERFORMANCE CAM

A powerful 90 amp (1269 watt) alternator ensures you'll always have plenty of charging power on board. The 600 SCi model meets emissions requirements as set forth in the EU RCD and is CE marked when equipped with the optional X-Haust Noise Reduction system. Optional Integrated Transom System (ITS) features integral power steering cylinders, making the transom more aesthetically pleasing and simplifying installation. Bravo One XR® and Bravo One XR® Sport Master (standard or short) drives offer a wide range of options to fit virtually any performance boat application.



600 SCI SPECS

HORSEPOWER AT TRANSOM	600
FULL THROTTLE RPM	4800-5200
DISPLACEMENT	8.2 L
BORE & STROKE	4.47 x 4.00 IN/113 x 102 MM
CYLINDERS/ENGINE CONFIG	V8
ALTERNATOR	90 AMP
FUEL REQUIREMENT	87 Posted Pump Octane (R+M/2), (95 RON) International
FUEL SYSTEM	Computer Controlled Sequential Multi-Port Electronic Fuel Injection (EFI)
GEAR RATIO	1.35:1, 1.50:1
WARRANTY	1-Year Limited For Recreational Boating
CONTROLLER	PCM Distributorless
TRANSMISSION	Mercury Racing Dry Sump
DRIVE UNIT	Bravo One XR, Bravo One XR Sport Master, (Std. Or Short), (Integrated Transom System Optional)
LENGTH-FROM BACK OF BLOCK ¹	35.7"
WIDTH	33"
HEIGHT	27.9"

¹Includes transmission





NATURALLY ASPIRATED

WIDE OPEN SPRINT

Often the race is won at the starting line. Drop the throttle. Leap out of the hole. Get gone while the pack is still bow up. With a mountain of torque and snappy throttle response a fuel-injected big block from Mercury Racing will put you out front.



565/520

FLEX SOME MUSCLE

These fuel-injected big block engines produce stout torque and incorporate the benefits of digital controls and closed cooling. Each is hand-assembled by the pros in the Mercury Racing engine shop, so you know the quality has been built in. Not your daddy's big block, indeed.



565 ■ 520

565

STROKER CRANK / DUAL INTAKES

Stroked to 8.7 liters, the Mercury Racing 565 features high-performance aluminum cylinder heads, a free-flowing custom intake manifold with dual electronic throttle bodies, stout H-beam connecting rods and tuned sweeper headers. Closed cooling and a high-performance oiling system help this motor keep its cool while it cranks out the power on 89 octane fuel. Exposed mesh flame arrestors look the business.

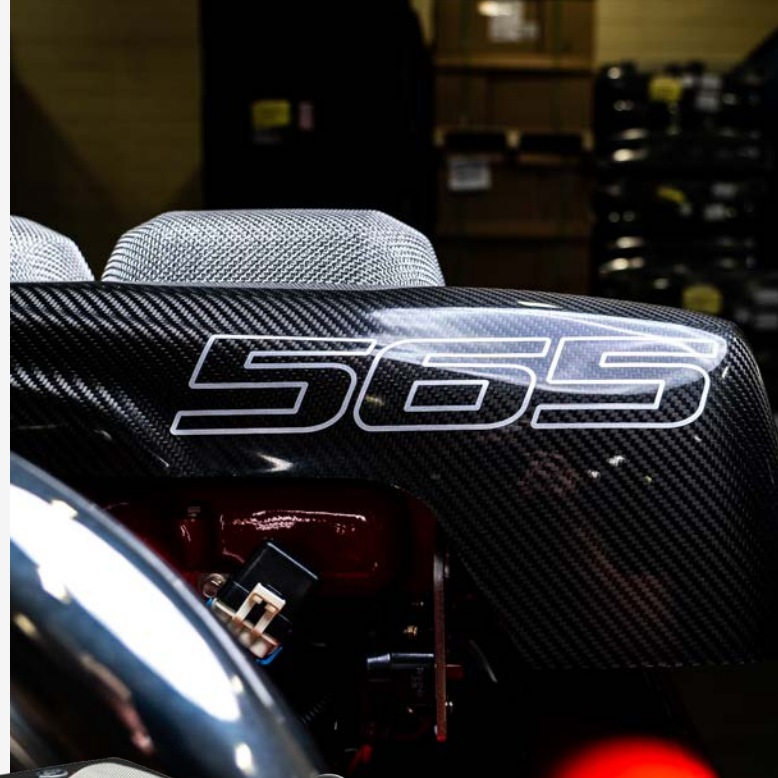

520

REPOWER HERO / 87 OCTANE

Powerful, durable and versatile. We bored the Mercury Racing 520 to 8.6 liters so it can make 520 honest horsepower on 87 octane fuel, without breaking a sweat. Cast exhaust manifolds and low-profile intake make it easy to drop this engine into a variety of boats. Repower a classic with electronic fuel injection, Digital Throttle and Shift (DTS) and the latest Bravo One XR® drives.



565 SPECS

HORSEPOWER AT TRANSOM	565
FULL THROTTLE RPM	5000-5400
DISPLACEMENT	8.7 L
BORE & STROKE	4.466 x 4.25 IN/113 x 108 MM
CYLINDERS/ENGINE CONFIG	V8
ALTERNATOR	90 AMP
FUEL REQUIREMENT	89 Octane Minimum (R + M)/2, (95 RON)
FUEL SYSTEM	Sequential Fuel Injection
GEAR RATIO	1.35:1, 1.50:1
WARRANTY	2-Year Limited For Recreational Boating
CONTROLLER	1 X PCM; 1 X TCM
DRIVE UNIT	Bravo One XR, Bravo One XR Sport Master, (Std. Or Short), (Integrated Transom System Optional)
LENGTH-FROM BACK OF BLOCK ¹	34.2"
WIDTH	33.8"
HEIGHT	26.9"

¹Includes transmission

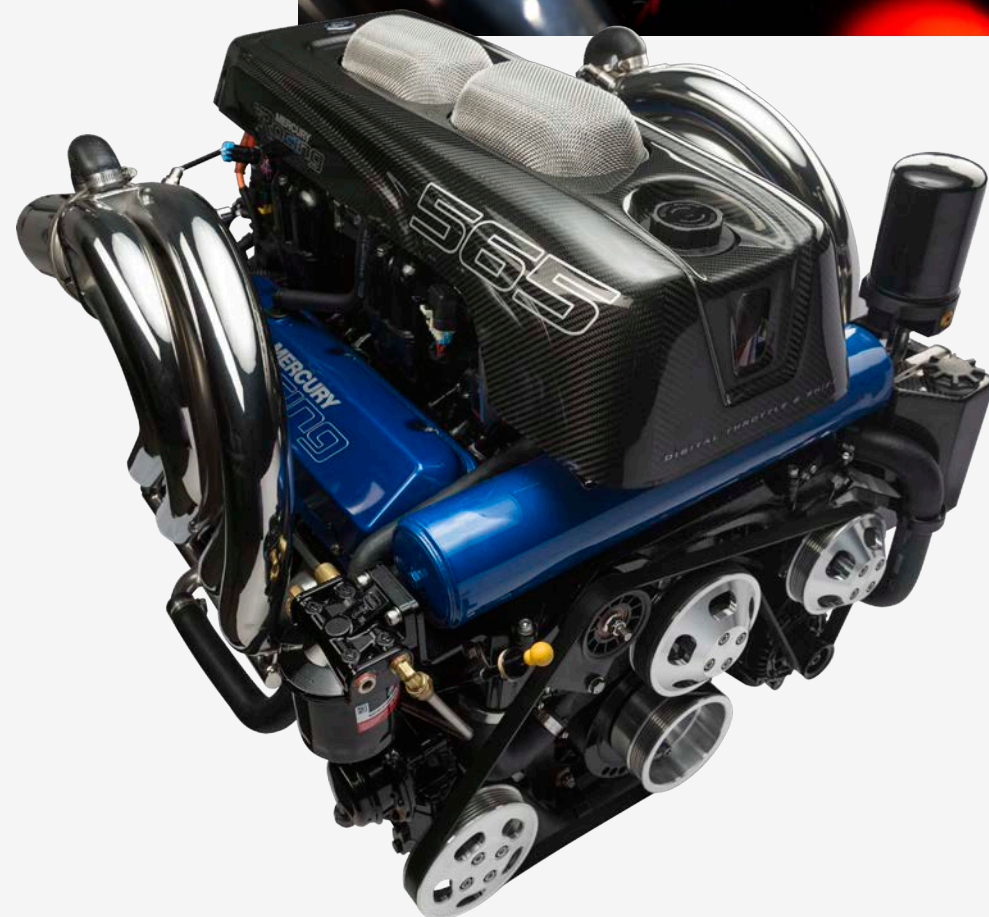

520 SPECS

HORSEPOWER AT TRANSOM	520
FULL THROTTLE RPM	4800-5200
DISPLACEMENT	8.6 L
COMPRESSION RATIO	8.7:1
BORE & STROKE	4.56 x 4.00 IN/115.8 x 101.6 MM
CYLINDERS/ENGINE CONFIG	V8
ALTERNATOR	65 AMP
FUEL REQUIREMENT	87 Octane Minimum (R+M/2), (91 RON) Global
FUEL SYSTEM	Sequential Fuel Injection
WARRANTY	2-Year Limited For Recreational Boating
CONTROLLER	PCM
DRIVE UNIT	Bravo One XR, Bravo One XR Sport Master (Std. & Short), Bravo Three XR, (Integrated Transom System Optional)
LENGTH-FROM BACK OF BLOCK ¹	34.2"
WIDTH	33.8"
HEIGHT	24.2"

¹Includes transmission





DRIVES



M8

A short, surface-piercing gearcase allows the engines to be mounted two inches deeper in the boat, which lowers the center of gravity, improving boat handling and overall performance. It also provides more flexibility in boat hatch styling. The M8 features twin-pinion drive and robust internal components rated to handle up to 1600 lb. ft of torque and 1600hp. Its dry sump design reduces parasitic power losses. A standard active anode provides enhanced corrosion resistance.



M6

The legendary M6 drive features a race-proven twin-pinion gear shaft design which splits the torque load for a higher power capacity while maintaining a slim, surface-piercing gearcase shape for maximum efficiency. Forged lower gears are designed to handle higher torque loads while an innovative dry sump lubrication system ensures maximum efficiency and power output.

TRANSMISSIONS

Mercury Racing transmissions are engineered to be rugged and reliable. Each is designed to handle the power of a high-performance marine engine in the most-stressful duty cycle imaginable while also being as compact as possible. A dry sump design limits parasitic power loss typical to an oil bath design. Hydraulic shifting is smooth, precise and responsive to input from Mercury Racing Digital Zero Effort controls.



BRAVO ONE XR®

Intended for single, twin and triple applications with engines up to 600hp in boats capable of up to 85 mph top speed. The Bravo One XR® is designed for high-performance applications, with dual water pickups, heavy-duty U-joints, a heavy-duty stainless steel prop shaft, billet aluminum bearing carrier, upgraded upper thrust bearings and net forged straight cut bevel gears for enhanced strength.



BRAVO ONE XR® SPORT MASTER

The surfacing Sport Master gearcase offers heavy-duty durability for boats that travel in excess of 85 mph, with four-slot low water pickups and a crescent leading-edge design that reduces drag as much as possible to maximize efficiency and speed. The one-piece gearcase housing and skeg are precision CNC machined for perfect symmetry that results in improved handling at higher speeds.

- Model shown with accessory Integrated Transom System



BRAVO ONE XR® SPORT MASTER SHORT

The same super hydrodynamic design as the Sport Master, with a two-inch shorter length. This permits lowering the transom X dimension by two inches, and mounting the engine two inches lower in the boat, while maintaining an optimal propeller position. Gain engine hatch clearance and lower overall center of gravity for improved handling.



BRAVO THREE XR®

The ideal drive option for Mercury Racing 520 engines in heavier cruiser boats. Heavy-duty components plus dual contra-rotating propellers provide added blade area to help lift a heavy boat out of the hole. The Mercury Racing Bravo Three XR® prop sets feature added cup to combat cavitation in higher horsepower applications. A large-diameter four-blade forward propeller followed by a smaller diameter three-blade aft propeller offer incredible handling, improved fuel economy at cruise speed, and improved boat control around the dock.

PROPELLERS





PRO AND LAB FINISHED PROPELLERS

Mercury Racing engineers and propeller artisans turn stainless steel castings into a perfect work of performance art. Most Mercury Racing propellers are offered in precise half-inch pitch increments you can use to dial in optimal RPM at wide-open throttle. Pro Finish models are hand-finished and fine-tuned with perfectly matching cup heights and a custom blade thickness profile. Lab Finish props are the ultimate performance propeller for light-weight boats running over 80 mph, with additional blade thinning to cut through the water with less power-robbing drag and an increase in top-end RPM. These blueprinted propellers feature perfectly matched blade profiles for consistent RPM in multi-engine boats.



ART OF SPEED

Mercury Racing props are designed to maximize boat performance and handling in any application, from pleasure boating to poker runs to all-out competition. Our artisans handcraft each propeller into a precision-tuned work of art, customized for a specific boat type and performance goal. Each propeller is zero balanced and measured to ensure consistent performance.



CNC CLEAVER

Pitch, diameter, and rake are perfectly true on every Mercury Racing CNC propeller to ensure that lift, handling, and speed characteristics are absolutely consistent. Thousands of pitch, rake and diameter combinations are available to dial in the maximum performance of almost any high-performance boat. Each CNC Cleaver propeller is custom made to order.

PROP SLIP CALCULATOR

The Mercury Racing Prop Slip Calculator app makes prop testing easier and more accurate. Prop slip is the difference between actual and theoretical travel resulting from a necessary propeller blade angle of attack. Measuring prop slip is the best way to match prop blade diameter and area to engine horsepower and rpm, the key to achieving peak propeller efficiency. The Mercury Racing Prop Slip Calculator App is a great tool that provides much more information than just slip. Download "PropSlipCalc" for iOS or Android free from Apple iTunes or Google Play Store.

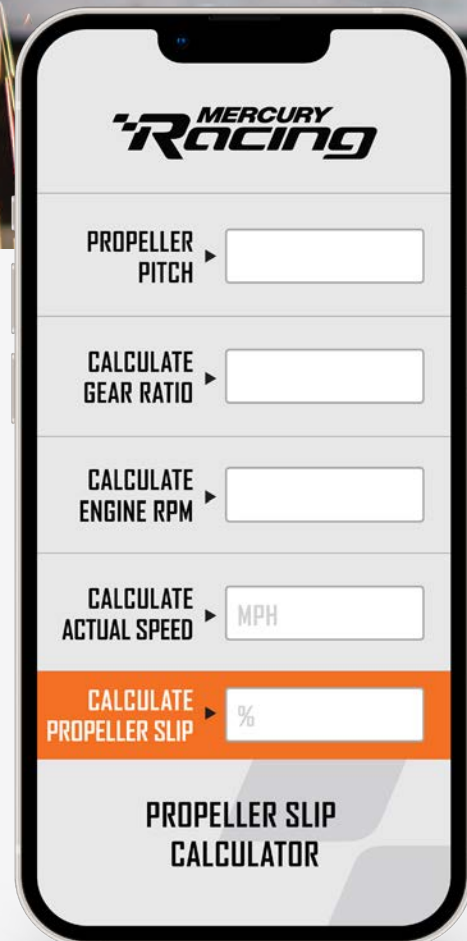

ACCESSORIES



DIGITAL ZERO EFFORT CONTROLS

Digital Zero Effort Controls replace the lag and hesitation of traditional throttle and shift cables with digital precision, resulting in smooth shifting and instant throttle response. Ergonomic design features short-throw levers for effortless shifting and ultra-fast throttle response, and the robust stainless-steel levers offer unmatched durability in the offshore environment. Digital Zero Effort Controls can provide automatic throttle synchronization and shadow mode for up to six engines (where two levers operate six engines).



K-PLANE TRIM TABS

Considered the gold standard of trim tab design, Mercury Racing K-Planes® are designed to endure the punishing rigors of offshore racing and the most-demanding performance-boat applications. K-Planes feature a heavy-duty, corrosion-resistant aluminum casting with large support ribs for unparalleled durability. Hydraulic trim cylinders maintain position and react immediately to fingertip control from the helm to plane boats faster and keep them level for a smooth, controlled ride in a variety of conditions.



INTEGRATED TRANSDOM SYSTEM

The Integrated Transom System (ITS) for Bravo One XR® sterndrives features integral power steering cylinders which make the transom more aesthetically pleasing and simplify installation.



PERFORMANCE ACTIVE TRIM

Performance Active Trim automatically adjusts the sterndrive trim angle for optimal performance from hole shot to 50 mph. At speeds in excess of 50 mph, Performance Active Trim provides a seamless hand off from auto to manual operation to give the operator full control at higher speeds. Five selectable trim profiles allow the operator to personalize Performance Active Trim to a specific driving style and to compensate for changes in boat load and weather conditions, while maintaining fully automatic operation. This patented GPS-based control system is designed specifically for use with Mercury Racing sterndrives equipped with SmartCraft® Digital Throttle & Shift (DTS) technology and running with gearcases partially surfaced.

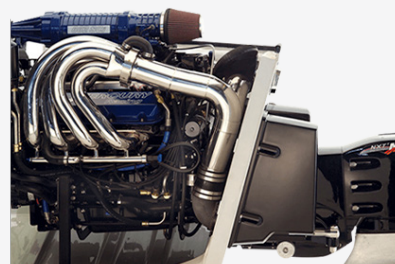

X-HAUST NOISE REDUCER

The Mercury Racing X-Haust Noise Reducer is a fully integrated sterndrive exhaust noise reduction system. X-Haust was developed primarily to bring the 600 Sci sterndrive engine packages, already certified by the European Union Recreational Craft Directive (RCD) requirements for exhaust emissions, in compliance with the stringent RCD noise regulations.

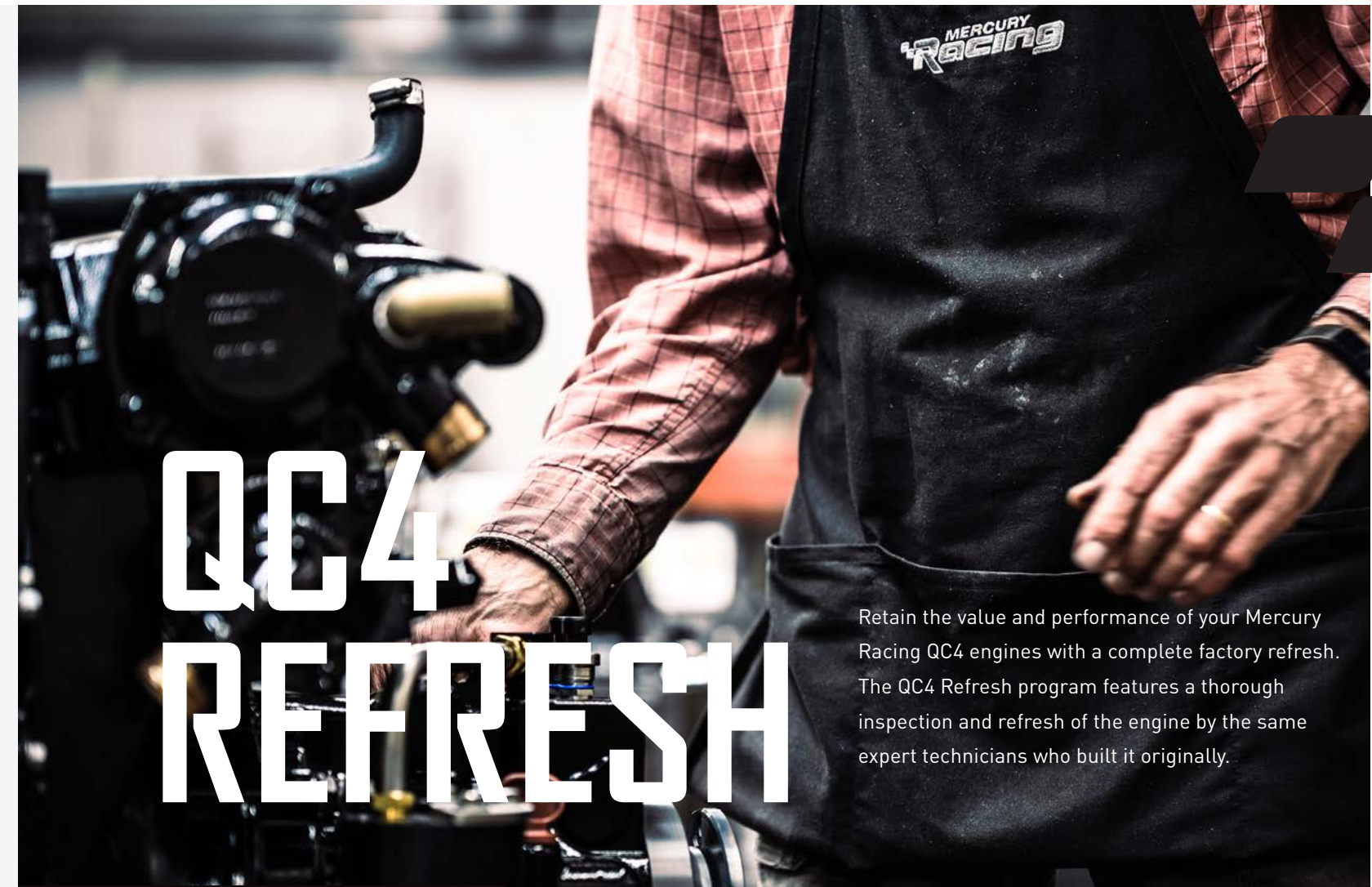

QC4 REFRESH

Retain the value and performance of your Mercury Racing QC4 engines with a complete factory refresh. The QC4 Refresh program features a thorough inspection and refresh of the engine by the same expert technicians who built it originally.

PROGRAM HIGHLIGHTS

Refreshed by Mercury Racing technicians

Factory original parts

Choose either a new or a reconditioned long block

Qualified on dyno full-power run and system check

Factory warranty on all purchased parts for non-competition 860-1550 models

ISO Certified Plant

For additional information go to mercuryracing.com/refresh

Here is a list of components that are inspected, refreshed, and/or replaced during the process. Contact your boat builder or Mercury Racing dealer to return your engine(s) for refresh.

COMPONENT	INSPECTED	REFRESHED	REPLACED
Cylinder Block	●	●	
Crankshaft	●		
Connecting Rods	●		
Camshafts	●	●	
Oil Pump	●	●	
Sea Pump	●	●	
Connecting Rod Bolts			●
Pistons & Rings			●
Bearings			●
Valve & Valve Springs			●
Valve Train Keepers & Retainers			●
Valve Guides	●		AS NEEDED
Valve Seats			2ND REFRESH
Timing & Accessory Drive Chains			●
Tensioner Guides			●
Primary Drive Sprocket			●
Turbos (1100-1550 Models Only)	●		
Exhaust Log	●		
Heat Exchanger	●		
Gaskets, Seals, Belts & Hoses			●



MercuryRacing.com

DECEMBER 2021 90-8M0189915

© 2021 Mercury Racing. All Right Reserved. Reproduction in whole or in part without permission is prohibited. Circle M Logo, K-Planes, Mercury, Mercury Racing, Mercury Racing Lab Finished, Mercury Racing Pro Finished, Skyhook, SmartCraft, Verado, VesselView, and Zero Effort are registered trademarks of Brunswick Corporation. Mercury Product Protection is a registered Service Mark of Brunswick Corporation. Wide Open is a trademark of Brunswick Corporation.

Product information in this brochure is accurate as of December 15, 2021. For the latest content, please visit MercuryRacing.com