

MERCURY

SmartCraft

SC5000 **System View**

Version 3.XX **Operation Manual**

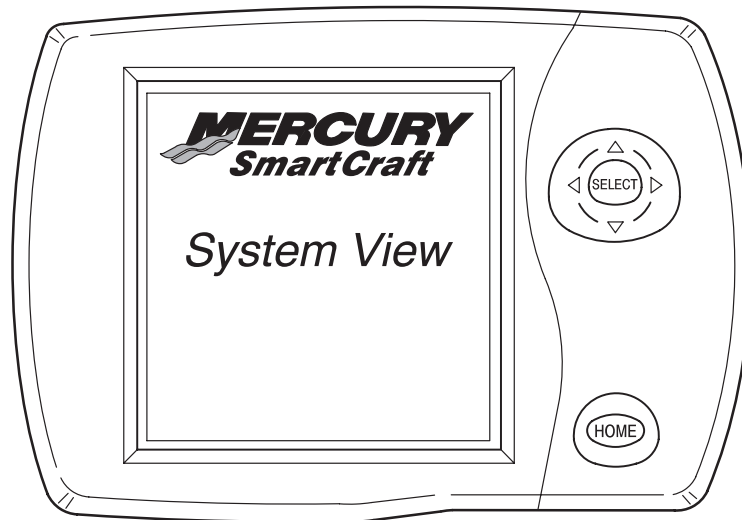

CONTENTS

Section 1 - Introduction

Section 2 - Getting Started

- Starting Up the System View
- Display Screens

Section 3 - Propulsion

- Engine RPM and Speed
- Engine RPM Synchronizer – Twin Engines
- Engine Data Screen (s)
- Trim Position
- Troll Control
- Peak Speed at RPM

Section 4 - Vessel

- Steering Position
- Fuel, Water, and Waste Tank Level Status
- Vessel Status Data

Section 5 - Navigation/Fuel

- Vessel Course
- Next Waypoint
- Trip History
- Estimated Fuel Range
- Depth
- Air Temperature
- Seawater Temperature

Section 6 - Settings

- Contrast/Lighting/Clock
- Units/Language/Offsets
- Home Page Data
- Sensors
- Preferences
- Favorites/Page Status

Section 7 - Systems

- System Calibration
- Maintenance Log
- Active Alarms
- Alarm History

Section 8 - Installation

- System View Installation
- Wiring Information
- Installation Configurations

Section 9 - Index



INTRODUCTION

1



GETTING STARTED

2



PROPULSION

3



VESSEL

4



NAVIGATION/FUEL

5



SETTINGS

6



SYSTEMS

7



INSTALLATION

8



INDEX

9

Introduction

The SC5000 System View Display is a comprehensive boat information center. System View allows the boat operator to receive a wealth of critical operational information, displayed clearly and instantly at the helm on the LCD display. The System View continuously monitors and reports information ranging from basic operating data to detailed vessel environment information. System View covers water temperature and depth, engine trim status, boat speed, steering angle, system preventive maintenance reminders and systems diagnostics. System View also can be fully integrated with the boat's GPS, if equipped, to provide up to the minute course, speed, and fuel-to-destination information.

System View Displays Detailed Information in These Important Categories:

***NOTE:** The detailed information listed which is standard on some models may be optional on others, or may not be available on some models based on engine and system configuration.*

Propulsion Information Section 3

- Engine RPM combined with boat speed
- Twin engine synchronizer display
- Peak boat speed in conjunction with peak engine RPM
- Engine data screen(s)
- Troll control
- Trim position

Vessel Information Section 4

- Steering angle display
- Fuel tank, oil tank, water tank, and waste water tank level display
- Vessel status

Navigation and Fuel Section 5

- Direction to target waypoint information shows present course and current speed on a graphic compass rose
- Shows distance, time, speed, and fuel to next waypoint
- Resettable trip history shows miles per hour, miles per gallon, elapsed drive time, and amount of fuel consumed on current trip
- Water depth with depth history graph
- Sea water temperature with temperature history graph

Alarm, Diagnostic, and Maintenance Information Section 7

- Displays alarms and helpful information concerning alarm causes
- Automatic maintenance reminders and log recorder for periodic propulsion maintenance

Keypad Usage

The System View uses icons and text selection to perform all the functions.

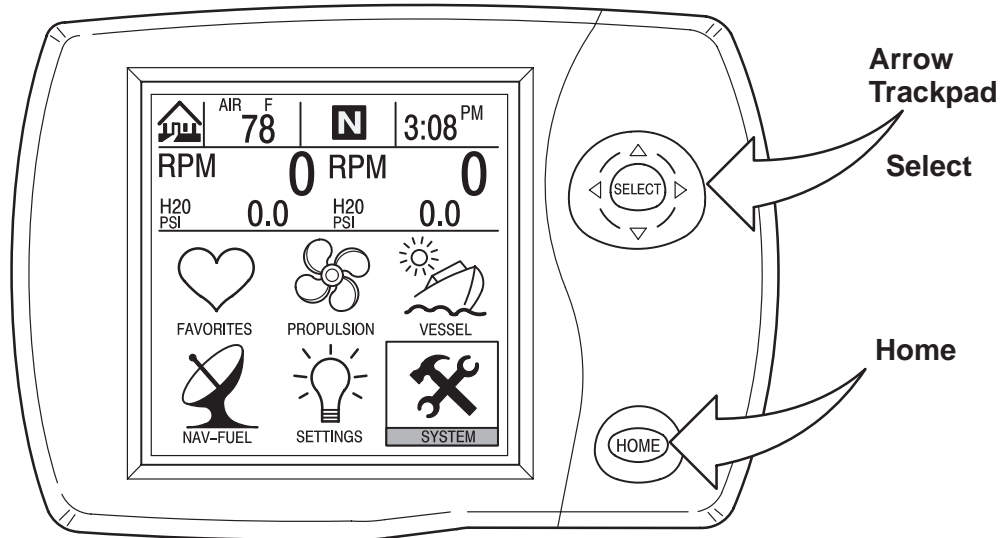

The **ARROW TRACKPAD** controls up and down and side to side movement for on-screen function prompts.



The **SELECT** key is used to select screen options and confirm data entry.



The **HOME** (power) key has two different functions:

- 1.) Pressing the **HOME** key will return the System View display back to the home page directory.
- 2.) The **HOME** key can be used to power-up or turn off the System View. Pressing and holding in the **HOME** key for 3 seconds with key switch turned off will power-up or turn off the System View.

Keypad Usage

REMOTE LOCATION – ELECTRONIC THROTTLE AND SHIFT MODELS

Console Remote Control – Single

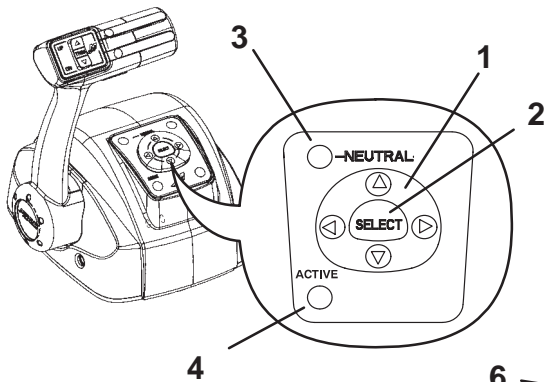

Console Remote Control – Dual

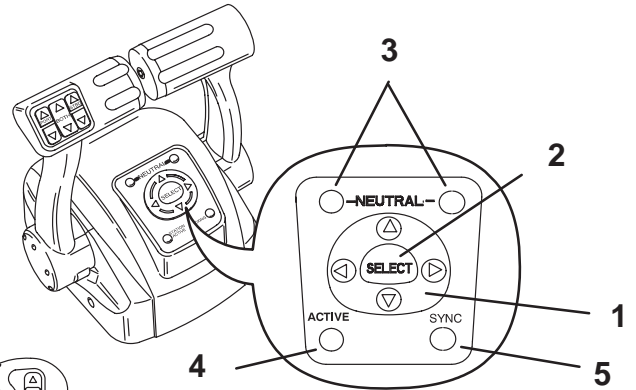

Panel Remote Control

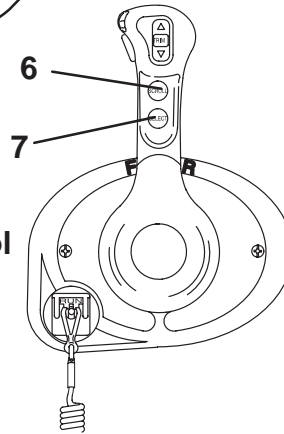

Console Remote Control

1. **Arrow Trackpad** – Can be used to operate the up and down and side to side movement for System View on-screen function prompts.
2. **Select Key** – Can be used to select System View on-screen options and confirm data entries. Pressing the Select switch for 2 seconds will return the System View display back to the Home page.
3. **Neutral LIGHT** – The neutral light is illuminated when the engine is in neutral gear position. The light blinks when engine is in warm up mode.
4. **Active LIGHT** – The active light is illuminated to show the remote control is active and ready for use
5. **Sync LIGHT** – The sync light is illuminated when the auto synchronizing feature is engaged. The auto synchronizing will automatically engage when both engines are above 900 RPM for 2 seconds and the throttles are within 10% of each other. The auto synchronizing will operate up to 95% throttle opening. The auto automatically engages as soon as the engines meet these conditions.

Panel Remote Control

6. **Scroll Key** – Can be used to scroll through System View displays on the display screen.
7. **Select Key** – Can be used to select System View on-screen options. Pressing the Select switch for 2 seconds will return the System View display back to the Home page.

GETTING STARTED

Section 2

Table of Contents



Starting up the System View	2-2
Display Screens	2-2
Start-up Screens	2-2
Home Page Screen	2-3
Data Display Screens	2-5
Alarm Message Screens	2-9

GETTING STARTED

Starting Up the System View

Turning on the main engine switch will start up the System View. The System View will move through a sequence of start-up screens shown below. Pressing **SELECT** will pause the screen.

Display Screens

Start-Up Screens

The start-up screens can be set to display home page (Step 1) or the last display shown before power off (Step 2). To select a setting, refer to “Setting/Preferences/Start-up Page” menu in Section 6.

1. Start-up screens will appear in sequence ending at the home page.
2. If set by owner, start-up screens will appear in sequence to the last display viewed before powering down.
3. Calibration screen – This screen only appears if initial setup calibration has not been performed. Press **SELECT** to perform calibration procedures. Please refer to System Calibration located in the SmartCraft System View installation instructions provided with the System View or engine service manual.

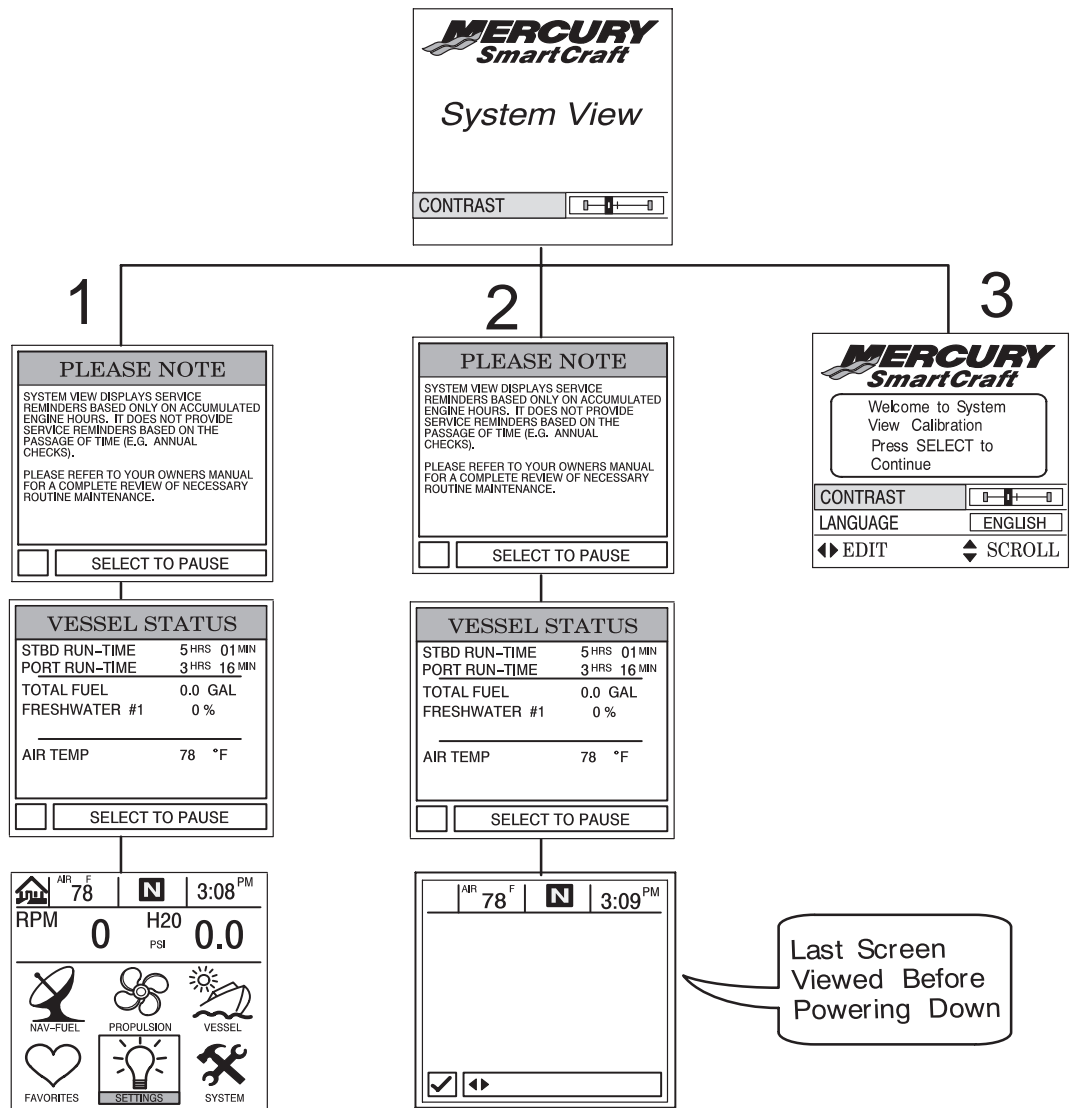

Display Screens

Home Page Screen

Across the bottom half of the home page you will find six on-screen main directory selections.

Use the trackpad to highlight the directory choice. Press **SELECT** to accept your choice and to open the directory screen.

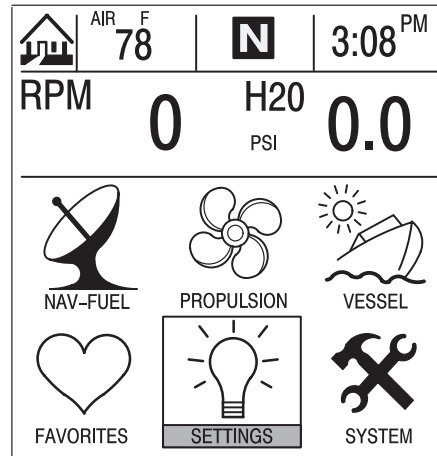

NAV-FUEL (See Section 5)

- Direction to target waypoint information shows present course and current speed on a graphic compass rose
- Shows distance, time, speed, and fuel to next waypoint
- Resettable trip history shows miles per hour, miles per gallon, elapsed drive time and amount of fuel consumed on current trip
- Water depth with depth history graph
- Sea water temperature



PROPULSION (See Section 3)

- Engine RPM combined with boat speed
- Twin engine synchronizer display
- Peak boat speed in conjunction with peak engine RPM
- Engine data
- Troll control
- Trim position



VESSEL (See Section 4)

- Steering angle display (Sterndrive only)
- Fuel tank, water tank, and waste water tank level display
- Vessel information



FAVORITES (See Section 6)

- Collection of Screens Selected by the User



SETTINGS (See Section 6)

- Contrast/Lighting/Clock
- Units/Language/Offsets
- Sensors
- Favorites/Page Status



SYSTEM (See Section 7)

- Maintenance Log
- Active Alarms
- Alarm History
- System Calibration

Display Screens

Home Page Screen (Continued)

The top half of the home page displays engine data and vessel data. The engine data is received from sensors on the engine and the vessel data is received by vessel sensors.

The initial screen layout takes one of two forms depending on whether one or two engines are installed. Defaults for the engine data include engine RPM and engine temperature. Default for vessel data is water depth.

The data displays can be selected by the user to display the functions. Refer to “Settings/ Preferences/Home Page Data” Menu in Section 6.

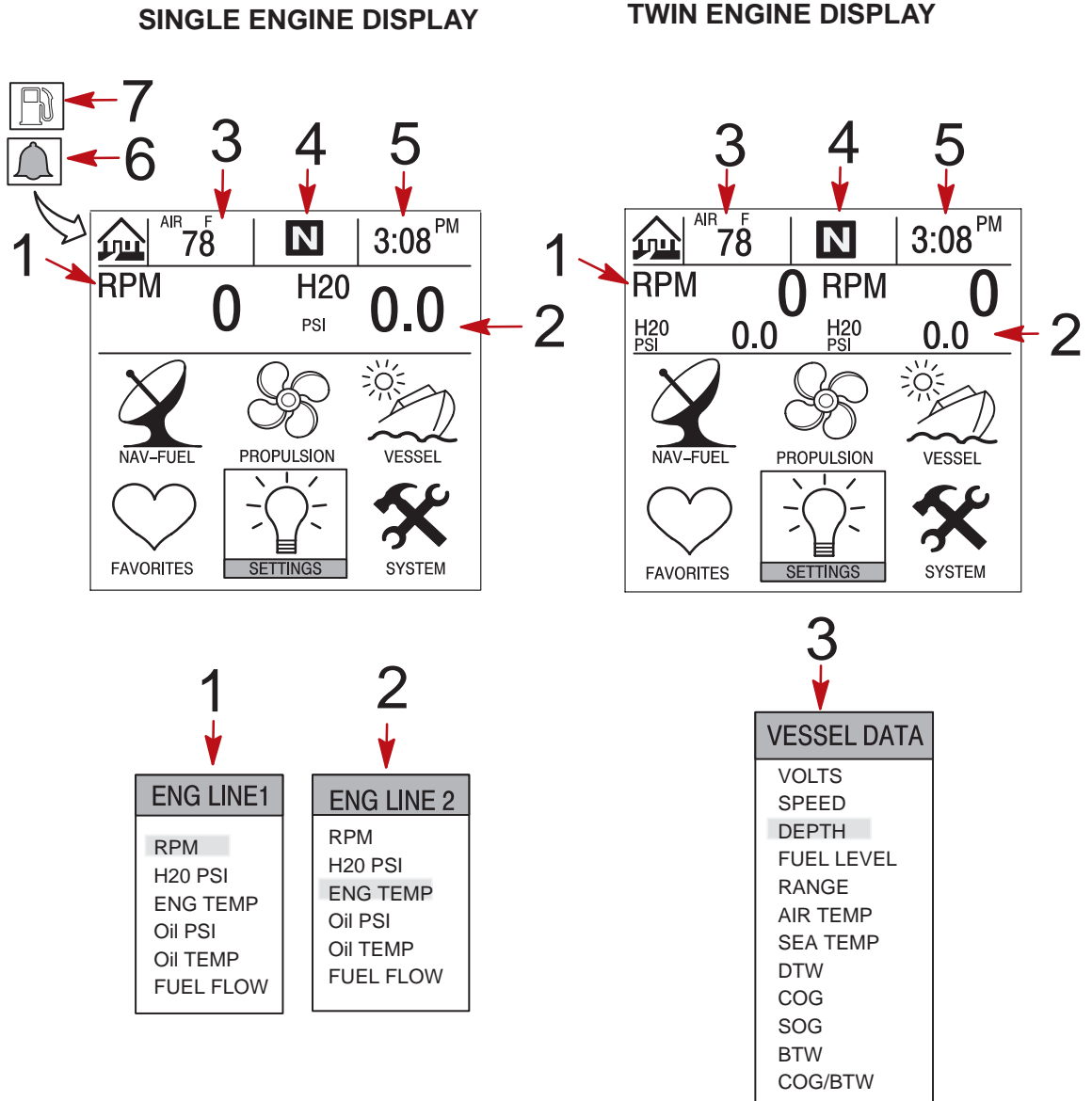

- 1** - Engine Line 1 – Refer to Section 6 for selection
- 2** - Engine Line 2 – Refer to Section 6 for selection
- 3** - Vessel Data – Refer to Section 6 for selection
- 4** - Engine gear position or run arrow
- 5** - Clock – Refer to Section 6 for setting
- 6** - Flashing Bell Icon – Warning alarm is activated
- 7** - Flashing Fuel Icon – Low fuel alarm

Display Screens

Data Display Screens

The data display screens can be selected from the main directory menu choices which are selected from the home page.

The current directory menu selection icon is displayed in top-left of the display.

The presentation of information on-screen will be shown in the information window located at the bottom on the screen.

Alarm Notice – When a problem is detected, the name of the offending alarm will appear in the information window and a bell symbol at the bottom of the screen flashes. The bell symbol will continue to flash as long as the alarm condition is still present. If there are multiple alarms, these will cycle on the display screen.

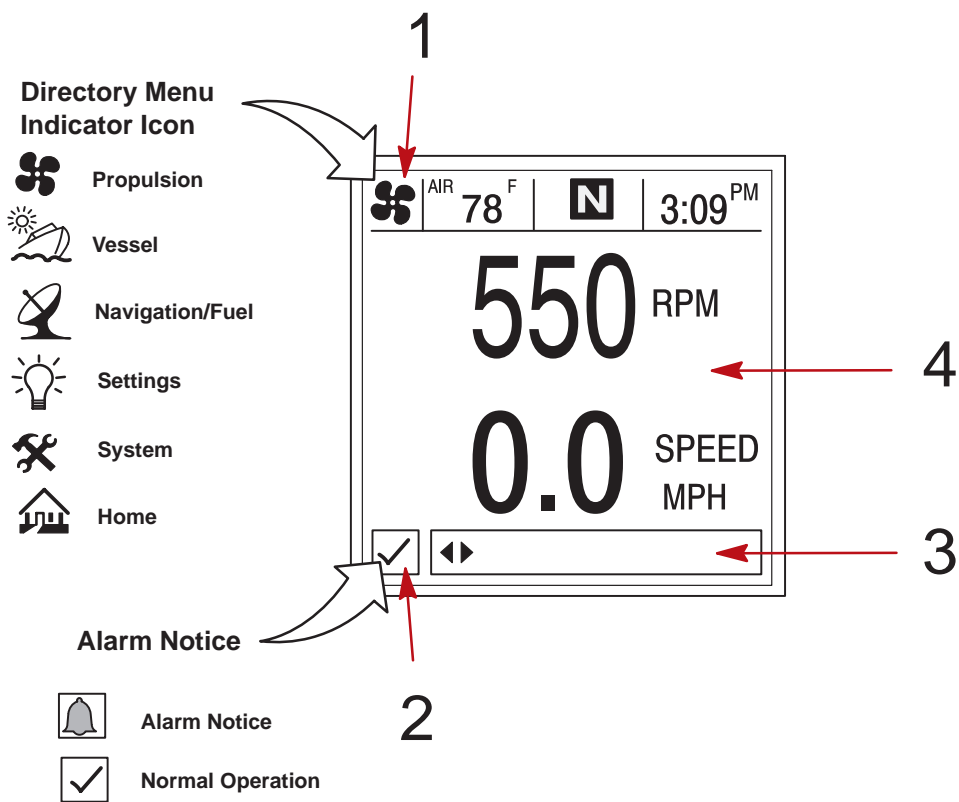











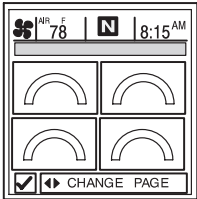

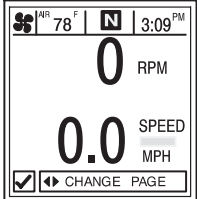
- 1 - Directory identification icon
- 2 - Alarm window
- 3 - Information window
- 4 - Display screen

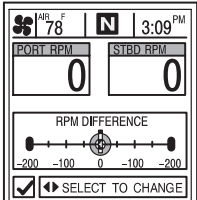
GETTING STARTED

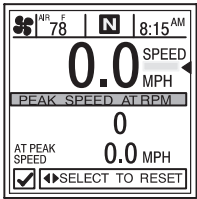
Display Screens

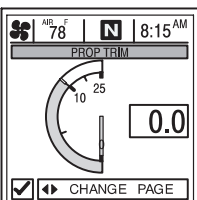
Data Display Screens

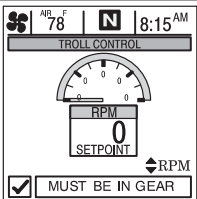









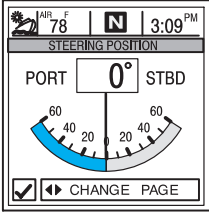

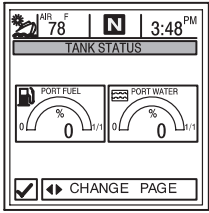
Glossary

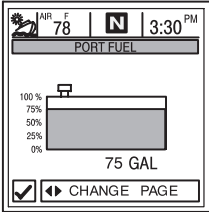
Data	Screen	Directory Location
<p>Engine Data Screen(s)</p> <p>Engine data screen(s) is a group of displays showing various engine data.</p>		 <p>PROPULSION</p>
<p>Engine RPM and Speed</p> <p>Displays engine RPM and boat speed.</p>		 <p>PROPULSION</p>
<p>Engine RPM Synchronizer</p> <p>Twin Engines – Displays the difference in engine speed (RPM) between the port and starboard engines</p>		 <p>PROPULSION</p>
<p>Peak Speed at RPM</p> <p>This screen records the top speed the boat reached and associated engine RPM as measured since the last reset.</p>		 <p>PROPULSION</p>
<p>Trim Position</p> <p>Display indicates the propulsion unit position achieved by setting trim and trailer position.</p>		 <p>PROPULSION</p>
<p>Troll Control</p> <p>Maintain a trolling speed without using the throttle.</p>		 <p>PROPULSION</p>

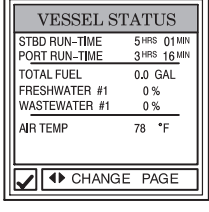
Display Screens

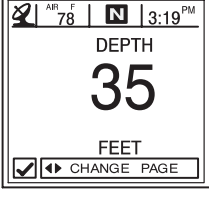
Data Display Screens

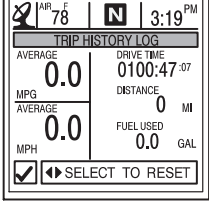
Glossary











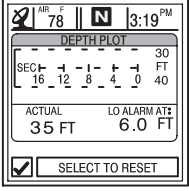

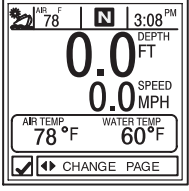
Data	Screen	Directory Location
<p>Steering Position Displays steering position in degrees.</p>		 <p>VESSEL</p>
<p>Tank Status Shows level of the vessel's tanks.</p>		 <p>VESSEL</p>
<p>Tank Levels Displays the level of each tank.</p>		 <p>VESSEL</p>
<p>Vessel Status Displays engine run time Total fuel remaining Additional tank levels Air temperature</p>		 <p>VESSEL</p>
<p>Depth Displays the depth of water.</p>		 <p>NAV-FUEL</p>
<p>Trip History Log Displays average fuel economy, average boat speed, total drive time, along with a corresponding distance traveled and fuel used.</p>		 <p>NAV-FUEL</p>

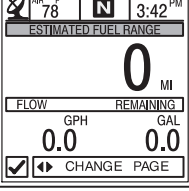
GETTING STARTED

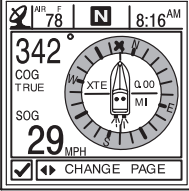
Display Screens

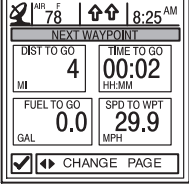
Data Display Screens

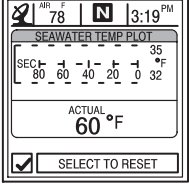
Glossary

Data	Screen	Directory Location
<p>Depth Plot Line</p> <p>Displays a plot line of depth vs. time as recorded over the last 16 seconds.</p>		
<p>Environment</p> <p>Displays speed, depth, air temperature, and sea water temperature.</p>		
<p>Estimated Fuel Range</p> <p>Displays estimated range and fuel remaining, as well as current total fuel flow.</p>		
<p>Navigation Screen 1</p> <p>Displays a compass and shows direction to a targeted waypoint.</p>		
<p>Navigation Screen 2</p> <p>Displays navigating data to a waypoint.</p>		
<p>Seawater Temperature Plot Line</p> <p>Displays a plot line of seawater temperature vs. time as recorded over the last 80 seconds. Also displays the current water temperature.</p>		

Display Screens

Alarm Message Screens

When a problem is detected, the System View will alert the operator. Use the following steps to determine the cause of the problem:

1. A pop-up screen will appear displaying an alarm message. If there are multiple alarms, the display will show the last alarm activated.
2. Press **SELECT** to clear the pop-up screen(s) and return back to the display screen that was being viewed. Bell icon will now be flashing and alarm message will be displayed on the bottom of the screen.
3. A number of different problems may be grouped together under one alarm message. To determine the exact cause of the problem, return back to the home page and access the **SYSTEM** directory. The **SYSTEM** directory will show the active alarm(s) causing the problem.
4. Refer to the "Active Alarms" in Section 7 or the *Engine Operation, Maintenance Manual* for further explanation of the problem and the correct action to take.

If the problem can cause immediate engine damage, the engine guardian system will respond to the problem by limiting engine power.

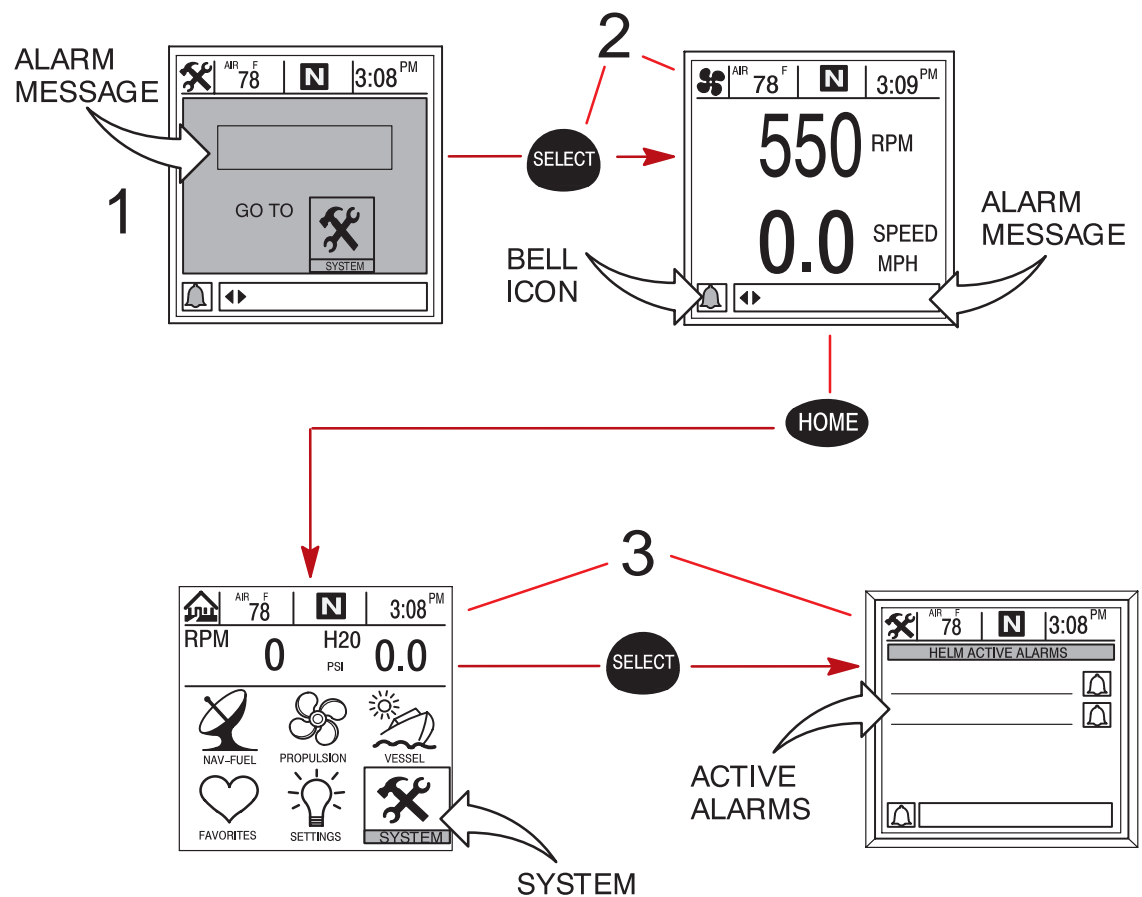

PROPULSION

Section 3

Table of Contents

Propulsion Information	3-2
Entering the Propulsion Directory	3-2
Propulsion Data Screens	3-3
Engine RPM/Speed	3-3
Peak Speed at RPM	3-3
Engine RPM Synchronizer – Twin Engines	3-4
Engine Data Screens	3-4
Trim Position	3-5
Troll Control	3-6

PROPULSION

Propulsion Information

This Section will give a complete description of the display screens in the **PROPULSION** directory of the System View.

Some of the propulsion functions are:

- Troll control
- Engine RPM combined with boat speed
- Twin engine synchronizer display
- Peak boat speed in conjunction with peak engine RPM
- Trim position
- Engine data screen(s)

Entering the Propulsion Directory

To access the **PROPULSION** directory, use the trackpad to highlight the **PROPULSION** directory from the menu choice. Press **SELECT** to accept and to open the directory.

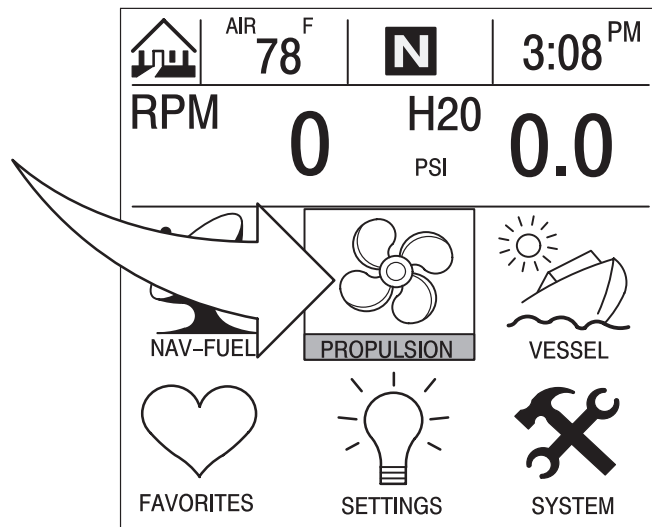

Propulsion Data Screens

Engine RPM/Speed

This screen displays engine speed (RPM) and boat speed.

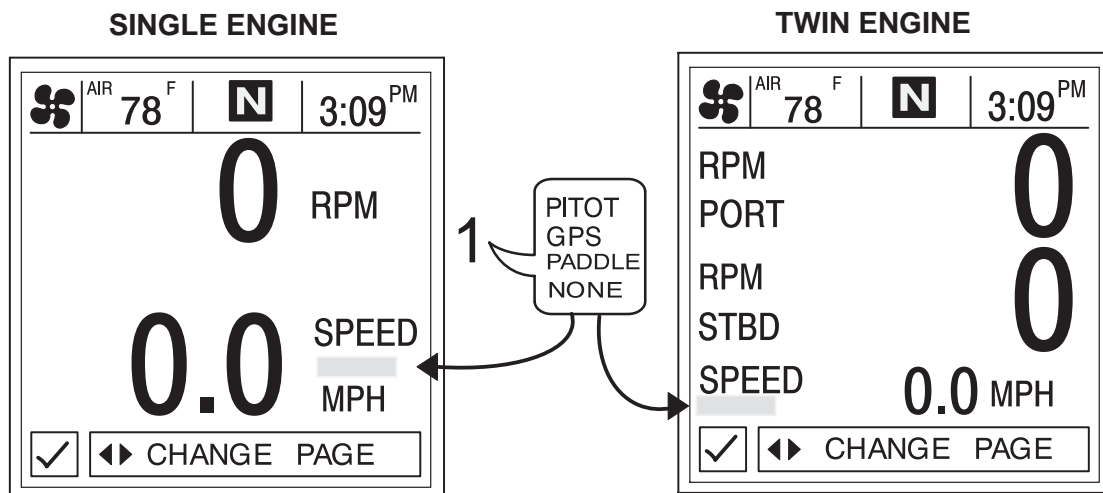

- 1 - Speed Sensors – This window shows the sensor that is currently sending the speed signal. The speed sensor is automatically selected based on what sensors are available.

Peak Speed at RPM

This screen records the top speed the boat reached and associated engine RPM as measured since the last reset.

To **Reset** the Peak Speed and corresponding RPM, press and hold the **SELECT** button momentarily.

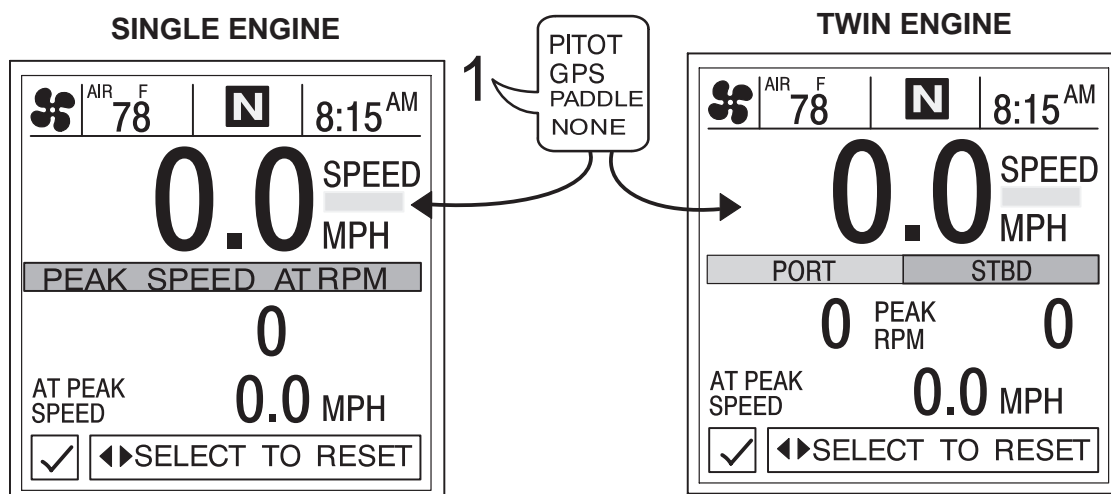

- 1 - Speed Sensors – This window shows the sensor that is currently sending the speed signal. The speed sensor is automatically displayed based on what sensors are available.

Propulsion Data Screens

Engine RPM Synchronizer – Twin Engine

This screen displays the difference in engine speed (RPM) between the port and starboard engines. Allows throttle adjustments to keep each engine running uniformly.

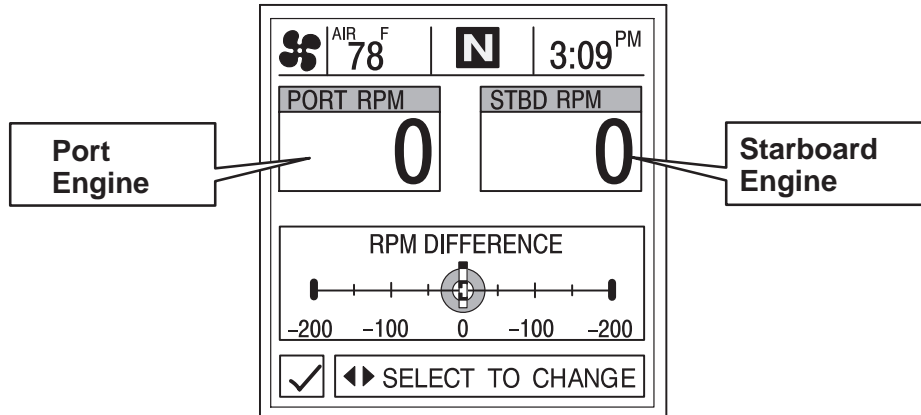

Engine Data Screen(s)

Engine data screen(s) is a group of displays showing various engine data.

NOTE: Not all screens listed may be available for your type of engine.

1. **ENGINE TEMP (Temperature)** – Displays engine temperature. The temperature will vary with air temperature, water temperature and operating conditions.
2. **H₂O PRESSURE (Water)** – Displays engine water pressure when engine is running.
3. **BATTERY** – Displays battery voltage level (condition) of battery.
4. **FUEL FLOW** – Displays current estimated engine fuel consumption in U.S. Gallons per hour (Gal/hr) or Liters per hours (Ltr/hr).
5. **OIL PRESSURE** – Displays engine oil pressure when the engine is running. The oil pressure may vary with engine speed, outside temperature and oil viscosity. While the engine is warming up, the oil pressure will be higher than when the engine is at normal operating temperature.

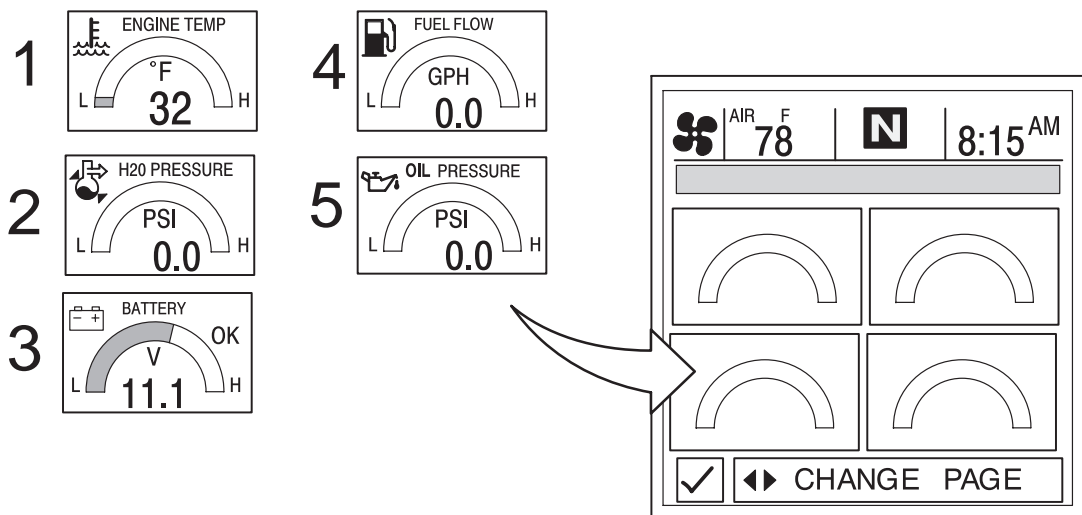

Propulsion Data Screens

Trim Position

Display indicates the propulsion unit position achieved by setting trim and trailer position.

SINGLE ENGINE

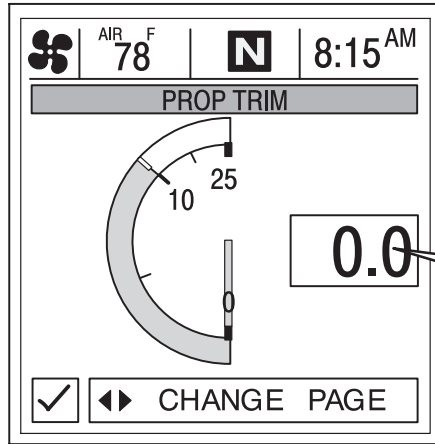

0 = Trimmed Down
 10 = Trimmed Up
 25 = Maximum Trailer

TWIN ENGINE

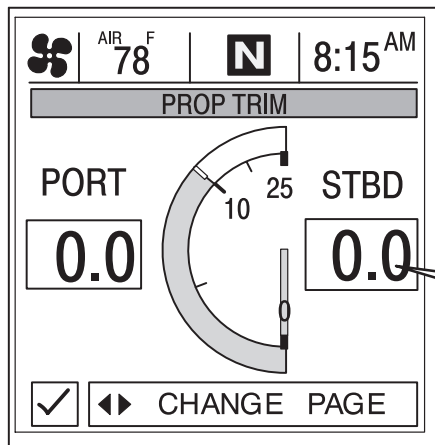

0 = Trimmed Down
 10 = Trimmed Up
 25 = Maximum Trailer

Propulsion Data Screens

Troll Control

NOTE: Depending on your engine type, Troll Control feature may not be available.

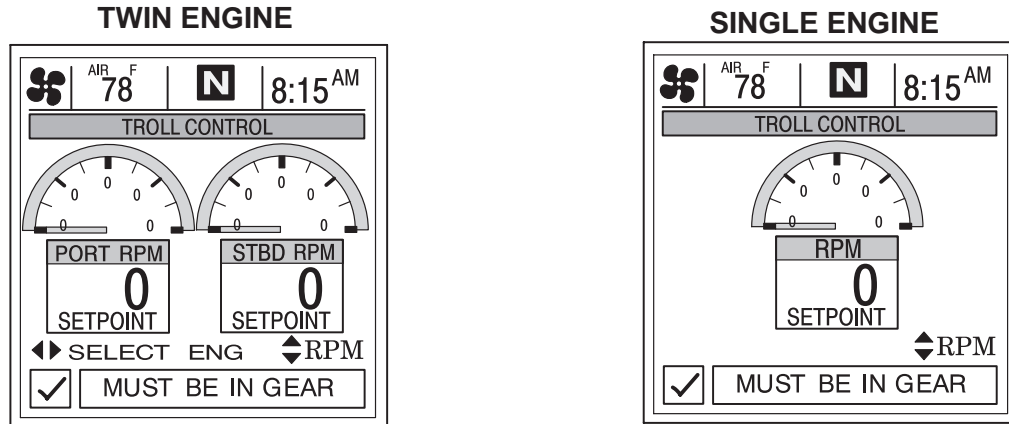

BASIC OPERATION

IMPORTANT: User must maintain constant helm control while using troll control to avoid obstacles.

With troll control, you can maintain a trolling speed within a range specific to engine type without using the throttle. See **NOTE:** following.

You must stay in the troll control screen while using troll control. If you leave the troll control screen, troll will automatically disengage.

You can shut off troll control anytime by pushing **SELECT**, moving the throttle, or shifting engine into neutral.

NOTE: Avoid using a very low rpm trolling speed for an extended period of time. Doing so could result in a low-battery voltage condition.

SETTING TROLL CONTROL

1. Press **◀▶** to display the **TROLL CONTROL** display screen.
2. With the engine running, shift engine into gear.
3. Set engine speed at idle.
4. Single Engine – Press **SELECT** to engage (turn on) the troll control.
Twin Engine – Press **SELECT** to choose which engine(s) are to be in troll control. Press **◀▶** to select **STBD**, **PORT**, or **BOTH**. Flashing “Setpoint” indicates chosen engine(s). Press **SELECT** a second time to engage troll control.
5. Press **▲▼** to set desired RPM.

NOTE: On dual station installations (2 System Views), you can hand-off the current troll control configuration from the troll control screen from one unit to the other by pressing **SELECT** to engage on the opposite unit.

TURNING OFF TROLL CONTROL

There are three ways to turn off the troll control:

- Press **SELECT**
- Move the throttle to a different speed
- Shift engine into neutral

VESSEL**Section 4****Table of Contents**

Vessel Information	4-2
Entering the Vessel Directory	4-2
Vessel Data Screens	4-3
Steering Position	4-3
Tank Status	4-3
Fuel Tanks	4-4
Water and Waste Tanks	4-4
Vessel Status	4-5

Vessel Information

This Section will give a complete description of the display screens in the **VESSEL** directory of the System View.

Some of the vessel functions are:

- Steering angle position
- Tank status for fuel, oil, waste, and water
- Vessel status

Entering the Vessel Directory

To access the **VESSEL** directory, use the trackpad to highlight the **VESSEL** directory from the menu choice. Press **SELECT** to accept and to open the directory.

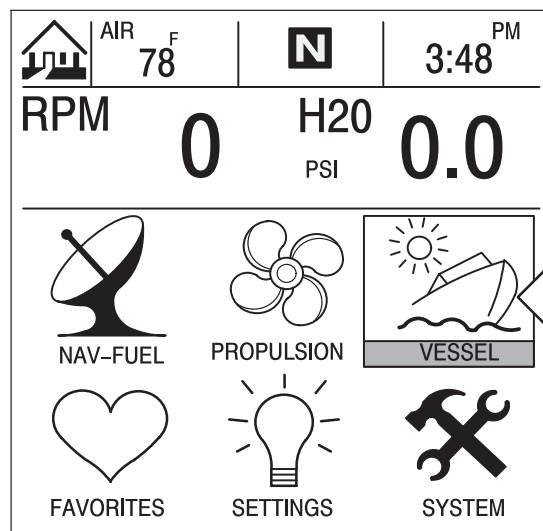

Vessel Data Screens

Steering Position

This screen displays steering position in degrees.

NOTE: Depending on your type of engine, this feature may not be available.

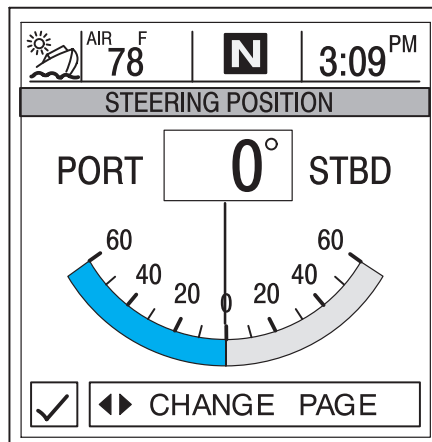

NOTE: If steering angle position is opposite the direction that it should be, it can be reversed so it is displayed properly. Refer to "Settings/Sensors/Invert Steering" Menu in Section 6.

Tank Status

NOTE: If your vessel installation includes tank level sensors, System View will display fullness level that is provided by the sensors.

The display screens show the level of the vessels tanks. The bar gauges and digital read-outs indicate the level of fullness of each tank.

SCREEN 1

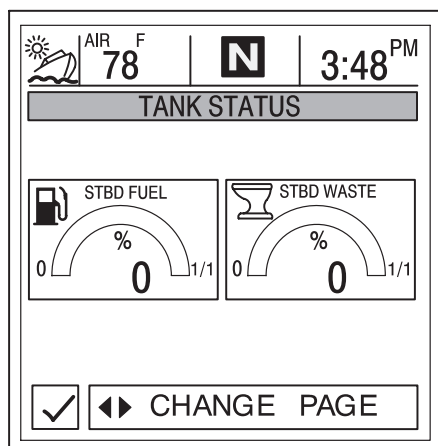

SCREEN 2

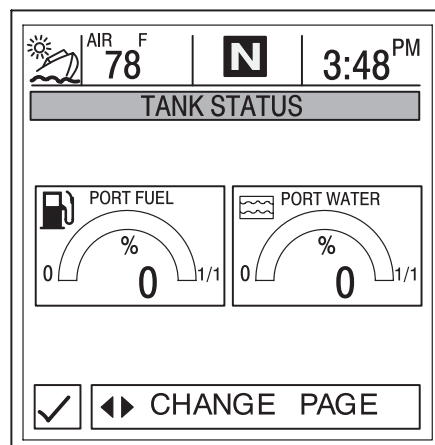

Vessel Data Screens

Fuel Tanks

Displays the level of each tank.

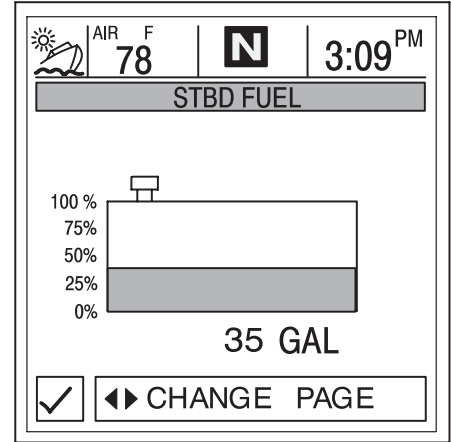
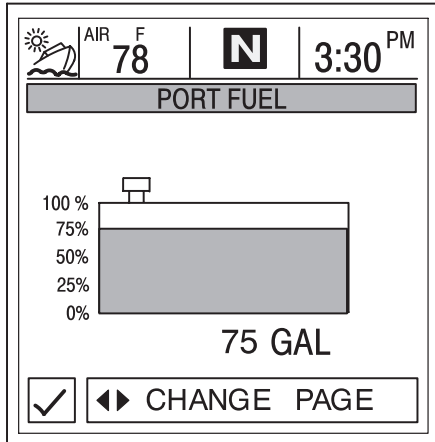

Water and Waste Tanks

Displays the level of each tank.

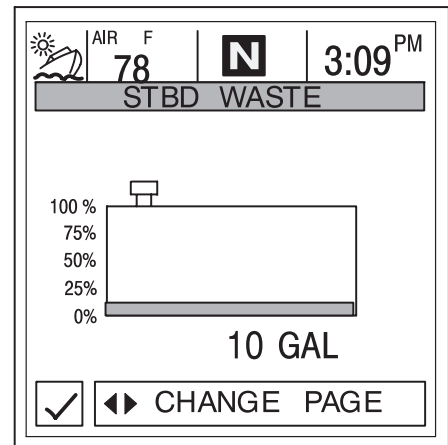
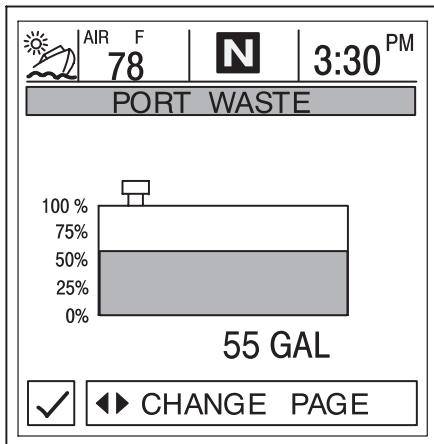

Vessel Data Screens

Vessel Status

Displays the current vessel information.

1. Displays run time in hours.
2. Displays the total fuel remaining.
3. Displays additional tank levels. Fresh water and waste water if connected.
4. Displays air temperature at sensor.

The screenshot shows a digital display titled "VESSEL STATUS". The display is divided into several sections. The top section shows run times for STBD and PORT. The middle section shows fuel and tank levels. The bottom section shows air temperature. At the bottom of the screen, there is a checkmark icon and a "CHANGE PAGE" button with left and right arrow icons.

VESSEL STATUS	
STBD RUN-TIME	5 HRS 01 MIN
PORT RUN-TIME	3 HRS 16 MIN
<hr/>	
TOTAL FUEL	0.0 GAL
FRESHWATER #1	0 %
WASTEWATER #1	0 %
<hr/>	
AIR TEMP	78 °F

1 → STBD RUN-TIME
2 → TOTAL FUEL
3 → FRESHWATER #1
4 → AIR TEMP

◀▶ CHANGE PAGE

NAVIGATION/FUEL

Section 5

Table of Contents

Navigation/Fuel Information	5-2
Entering the Navigation/Fuel Directory	5-2
Navigation/Fuel Data Screens	5-3
Vessel Course – Course Up	5-3
Next Waypoint Data	5-4
Trip History Log	5-4
Depth	5-5
Depth Plot Line	5-5
Environment – Speed, Depth, Air and Sea Water Temperature	5-6
Seawater Temperature Plot	5-6
Estimated Fuel Range	5-7

Navigation/Fuel Information

This Section will give a complete description of the display screens in the **NAV-FUEL** directory of the System View.

Some of the navigation/fuel functions are:

- Navigation screens
- Next waypoint data
- Trip history log
- Depth
- Depth plot line
- Depth, speed, air temperature, and water temperature
- Seawater plot line
- Estimated fuel range

Entering the Navigation/Fuel Directory

To access the **NAV-FUEL** directory, use the trackpad to highlight the **NAV/FUEL** directory from the menu choice. Press **SELECT** to accept and to open the directory.

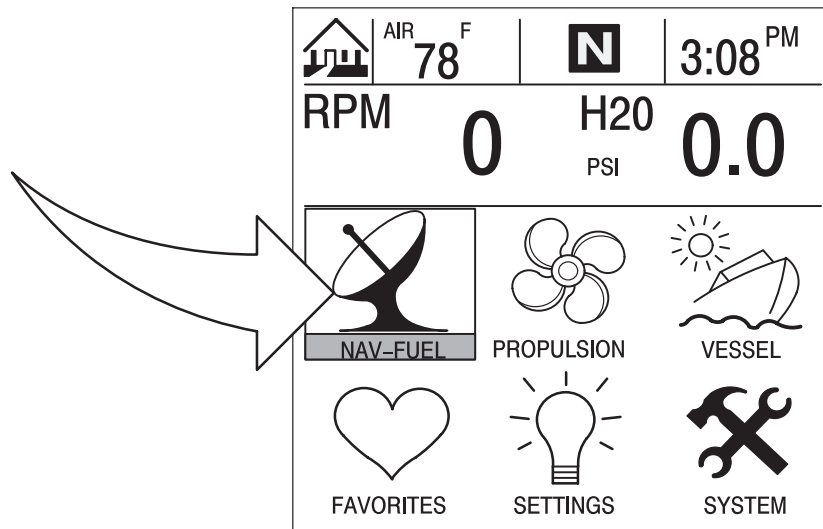

Navigation/Fuel Data Screens

Navigation Screens

IMPORTANT: This device is intended as a navigation aid and should not take the place of paper charts. A careful navigator never relies on one method to obtain position information.

NOTE: For use of the navigation screens, your vessel must include a GPS receiver with NMEA 0183 V1.5 or V2.0+ output and be connected to the System View.

The System View features two different navigation screens: Vessel Course and Next Waypoint Data. Next Waypoint Data provides course guidance to a destination waypoint, if programmed into your GPS navigation electronics.

SCREEN # 1 – VESSEL COURSE – COURSE UP

This vessel course – course up screen has a rotating compass ring that not only shows your direction of travel, but also the direction to a targeted waypoint. When you are not navigating to a waypoint, the compass will show your direction of travel. The boat pointer in the center of the compass ring shows current direction.

When a waypoint is set using a separate GPS unit, an X mark will appear on the compass ring. This X mark will indicate your waypoint. For instance, if the X mark lines up with the center of the boat pointer, you are going directly to the waypoint. If the boat pointer does not line up with the X mark, steer toward the X mark until it lines up with the center of the boat pointer– then continue in this direction until you reach your current target waypoint.

The middle of the compass shows the current cross track error (XTE). This is the distance you are off-course relative to the desired course.

Anytime a compatible GPS is connected, the current Speed Over Ground (SOG) as well as the Course Over Ground (COG) are displayed on the screen.

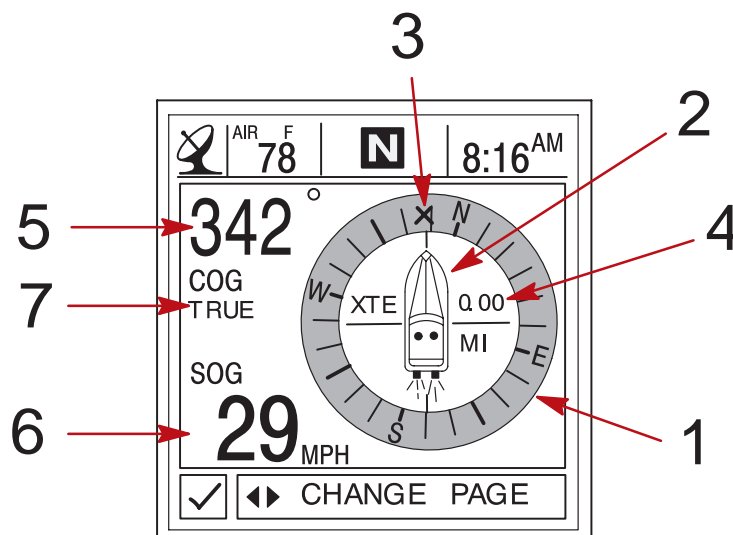

- 1 - Compass ring
- 2 - Boat pointer
- 3 - X – Mark (Gives the Direction to Steer)
- 4 - Cross track error
- 5 - Course over ground (COG)
- 6 - Speed over ground (SOG)
- 7 - GPS Heading – True or Magnetic – Refer to “Settings/Preference/GPS Heading” Menu in Section 6

Navigation/Fuel Data Screens

Navigation Screens

SCREEN # 2 – NEXT WAYPOINT DATA

When navigating to a waypoint, this screen will give you the following navigation information:

1. **DIST TO GO** – Remaining distance to the next waypoint.
2. **TIME TO GO** – Is the time that it will take to reach your waypoint at your present speed.
3. **FUEL TO GO** – Is the fuel it will take to get to your waypoint.
4. **SPD TO WPT** – Is the speed you are making towards your waypoint.

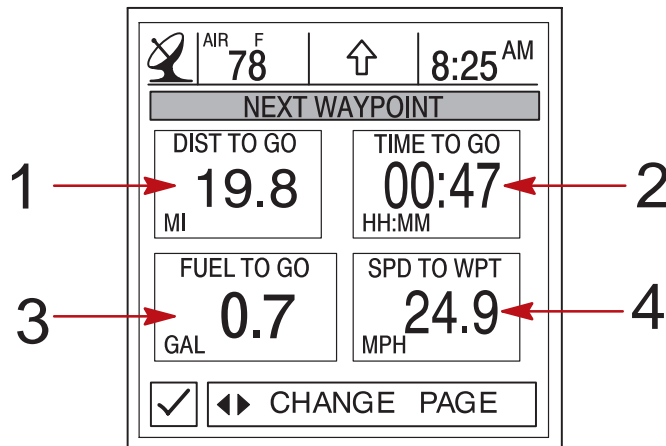

Trip History Log

This screen tracks your boat’s progress since last reset. Displays average fuel economy, average boat speed, total drive time, along with a corresponding distance traveled and fuel used.

To **Reset** trip history log, press and hold down **SELECT** for 5 seconds.

1. Displays the average distance per U.S. gallon or liter of fuel since the unit was last reset.
2. Displays the average speed of the boat since the unit was last reset.
3. Displays the time in hours of the engine usage since the unit was last reset.
4. Displays the total distance traveled since the unit was last reset.
5. Displays the total fuel used since the unit was last reset.

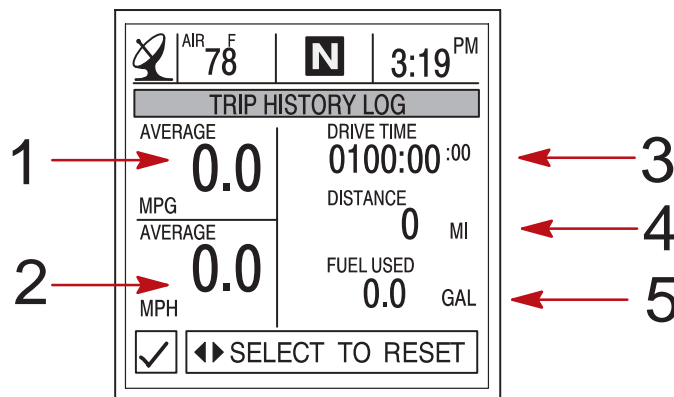

Navigation/Fuel Data Screens

Depth

DEPTH displays the depth of water.

NOTE: To set depth and shallow water alarm levels, refer to “Settings/Sensors” Menu in Section 6.

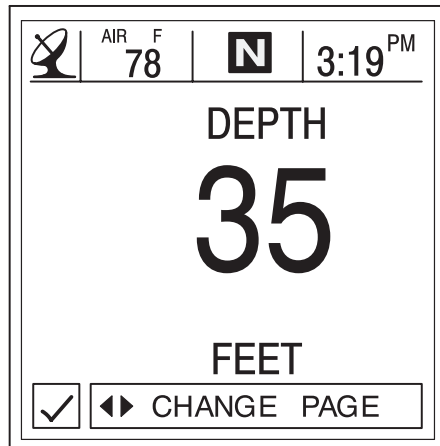

Depth Plot Line

DEPTH PLOT displays a plot of depth vs. time as recorded over the last 16 seconds.

NOTE: To set depth and shallow water alarm levels, refer to “Settings/Sensors” Menu in Section 6.

1. Displays depth plot line.
2. Displays current water depth.
3. Displays low water alarm setting.

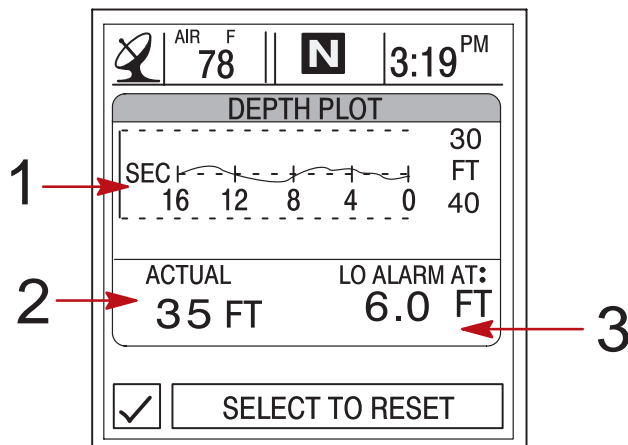

Navigation/Fuel Data Screens

Environment

This screen displays speed, depth, air, and sea water temperature.

1. Displays depth of water.
2. Displays speed of the boat.
3. Displays the air temperature.
4. Displays the sea water temperature.

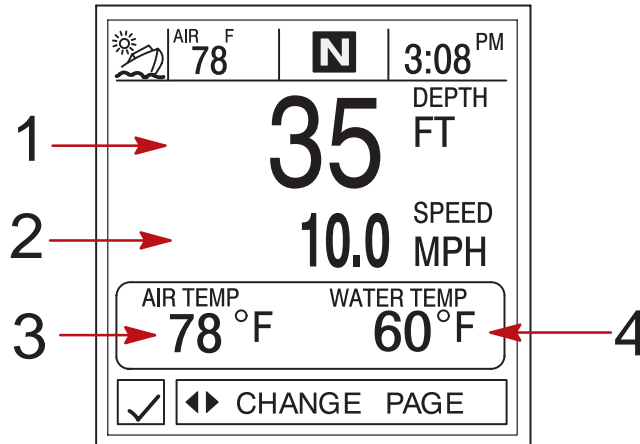

Seawater Temperature Plot

SEAWATER TEMP PLOT displays a plot of seawater temperature vs. time as recorded over the last 80 seconds. Also displays the current water temperature.

1. Displays sea water plot line.
2. Displays current water temperature.

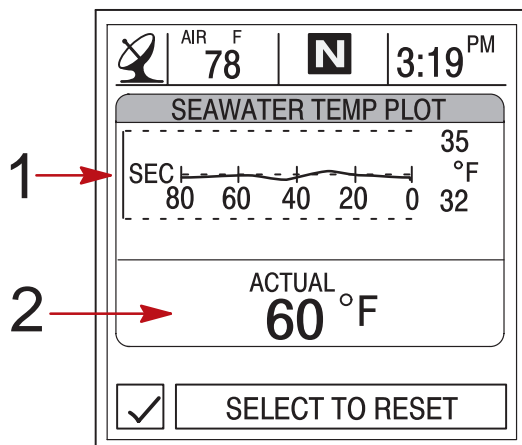

Navigation/Fuel Data Screens

Estimated Fuel Range

ESTIMATED FUEL RANGE displays estimated range and fuel remaining, as well as current fuel flow.

1. The estimated fuel range is based on boat speed, fuel consumption, and fuel remaining in the tank. The number displayed indicates an estimate of the distance you can travel on the remaining fuel. Speed input required (paddle wheel, pitot pressure, or GPS).
2. Displays the current vessel fuel consumption in U.S. gallons per hour or liters per hour.
3. Displays amount of fuel remaining.

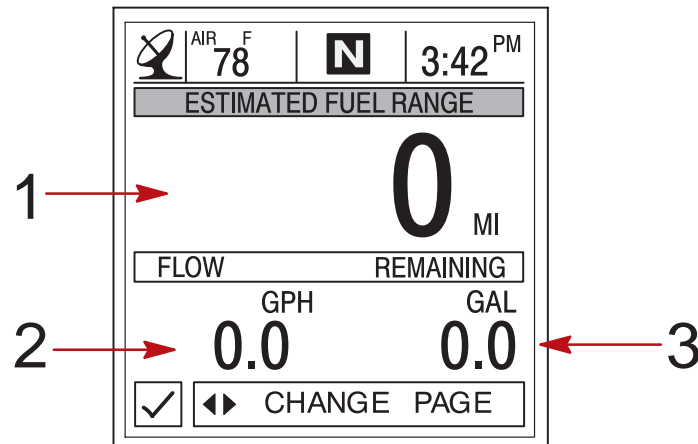

SETTINGS

Section 6

Table of Contents

Settings Information	6-2
Entering the Settings Directory	6-2
Settings Directory	6-2
Settings Options	6-3
Contrast/Lighting/Clock	6-3
Units/Language/Offsets	6-4
Home Page Data	6-5
Sensors	6-6
Preferences	6-7
Favorites/Page Status	6-8

SETTINGS

Settings Information

This Section will give a complete description of the Settings screens in the **SETTINGS** directory of the System View.

In this Section you can configure your System View to display the information the way you prefer.

Some of the Settings functions are:

- Customizing the home page data
- Contrast/Lighting/Clock
- Units/Language/Offsets
- Sensor settings
- Favorites/Page status
- Setting your preferences

Entering the Settings Directory

To access the **SETTINGS** directory, use the trackpad to highlight the **SETTINGS** directory from the menu choice. Press **SELECT** to accept and to open the directory screen.

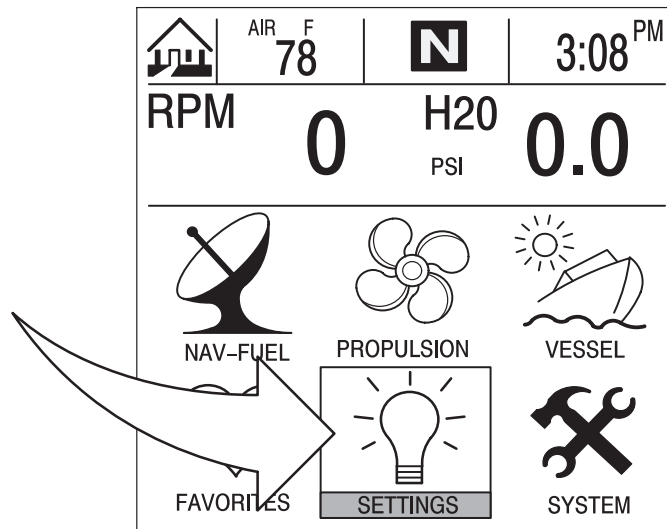

Settings Directory

Settings Directory Screen

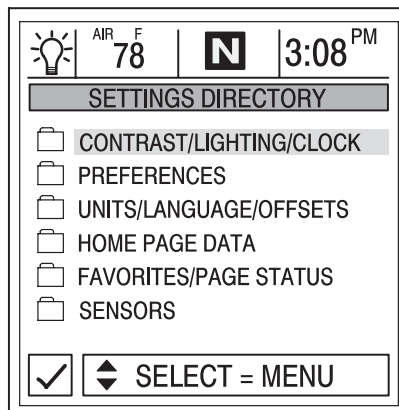

Settings Options

Contrast/Lighting/Clock

To adjust a setting:

1. Press ▲▼ to highlight the desired menu selection.
2. Press ◀▶ to edit the menu box.
3. Press **SELECT** to accept settings.

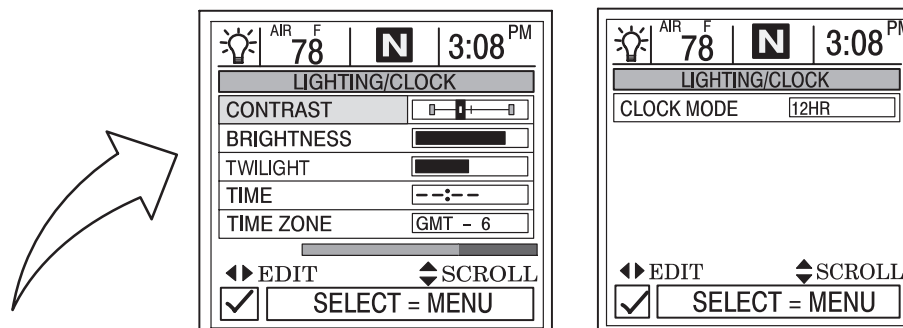

- CONTRAST** – Provides a slide bar to adjust the display screen contrast to compensate for changes in temperature or lighting conditions.
- BRIGHTNESS** – Provides a slide bar to adjust the display screen lighting level.
- TWILIGHT** – The twilight setting is a light sensor setting that adjusts the amount of light needed to automatically turn on the System View backlighting and the System Link gauge lighting. You can manually control when the backlighting turns on by adjusting the slide bar.
- TIME** – If no GPS is connected, press the horizontal arrows to the set the current time. If GPS is connected, follow time zone setting below.
- TIME ZONE** – Time zone setting is how many hours you are behind or ahead of Greenwich Mean Time (GMT). The chart below gives approximate GMT time zone settings for various longitudinal zones. Add one hour to the setting for daylight savings time.
- CLOCK MODE** – Select 12 hour or 24 hour clock set.

Longitudinal Zone	Time Zone Setting	DayLight Saving Time Zone Setting	Longitudinal Zone	Time Zone Setting	DayLight Saving Time Zone Setting
W180.0° to W172.5°	-12	-11	E007.5° to E022.5°	+1	+2
W172.5° to W157.5°	-11	-10	E022.5° to E037.5°	+2	+3
W157.5° to W142.5°	-10	-9	E037.5° to E052.5°	+3	+4
W142.5° to W127.5°	-9	-8	E052.5° to E067.5°	+4	+5
W127.5° to W112.5° (Pacific Standard Time)	-8	-7	E067.5° to E083.5°	+5	+6
W112.5° to W097.5° (Mountain Standard Time)	-7	-6	E082.5° to E097.5°	+6	+7
W097.5° to W082.5° (Central Standard Time)	-6	-5	E097.5° to E112.5°	+7	+8
W082.5° to W067.5° (Eastern Standard Time)	-5	-4	E112.5° to E127.5°	+8	+9
W067.5° to W052.5°	-4	-3	E127.5° to E142.5°	+9	+10
W052.5° to W037.5°	-3	-2	E142.5° to E157.5°	+10	+11
W037.5° to W022.5°	-2	-1	E157.5° to E172.5°	+11	+12
W022.5° to W007.5°	-1	0	E172.5° to E180.0°	+12	+13
W007.5° to E007.5°	0	+1			

Settings Options

Units/Language/Offsets

To adjust a setting:

1. Press ▲▼ to highlight the desired menu selection.
2. Press ◀▶ to edit the menu box.
3. Press **SELECT** to accept settings.

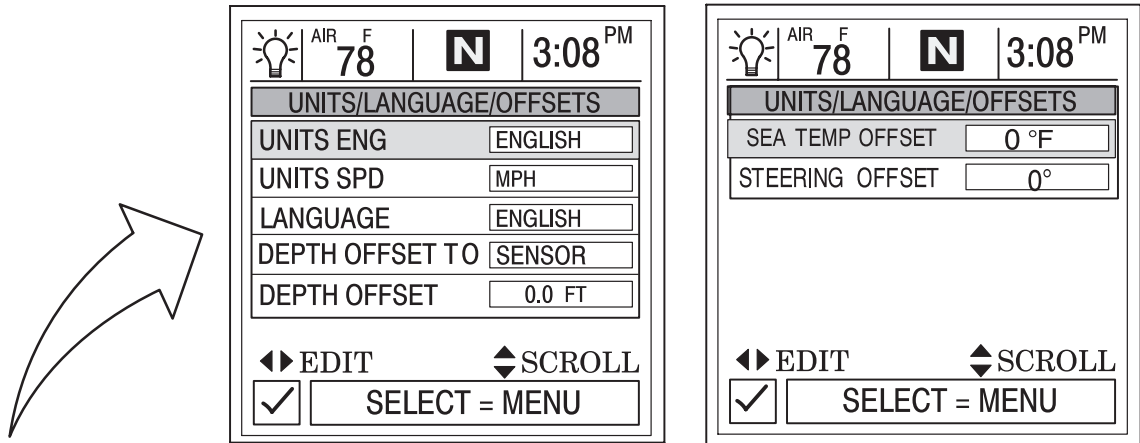

UNITS ENG – Lets you select English or metric format for unit measurements.

UNITS SPD – Lets you select the units at which speed is displayed. You may select from MPH (Miles Per Hour), KM/H (Kilometers Per Hour) or Knots.

LANGUAGE – System View displays only English at this time.

DEPTH OFFSET TO – Normally, this unit measures water depth from the face of the transducer (sensor). Since the transducer is below the water, this distance is not the exact water depth. You can change the depth reading using this depth offset feature. You have three depth offsets selections:

1. **SENSOR** – Will measure water depth from the face of the transducer. No setting to depth offset is necessary.
2. **WATERLINE** – Will give water depth from the surface of the water. You will need to change the depth offset setting below. Measure the distance between the face of the transducer and the water line. Add this measurement into depth offset menu box below.
3. **KEEL** – Will give water depth from the keel of the boat. You will need to change the depth offset setting below. Measure the distance between the transducer and the lowest part of the boat. Place this measurement into depth offset menu box below. This offset will be a negative value.

DEPTH OFFSET – Activate the depth offset feature by adding the measurement taken above to compensate for waterline or keel offset.

SEA TEMP OFFSET – The sea water temperature sensor can be calibrated to match actual sea water temperature. Calculate the difference in degrees that the sea water temperature is off and enter it into the menu window.

STEERING OFFSET – The steering sensor can be calibrated to compensate for inaccuracies. Calculate the difference in degrees that the steering sensor is off and enter it into the menu window.

Settings Options

Home Page Data

4. Look at the **HOME PAGE DATA** and determine if there is any data that you would like to change. Press ▲▼ to select function. Press ◀▶ to edit the function.

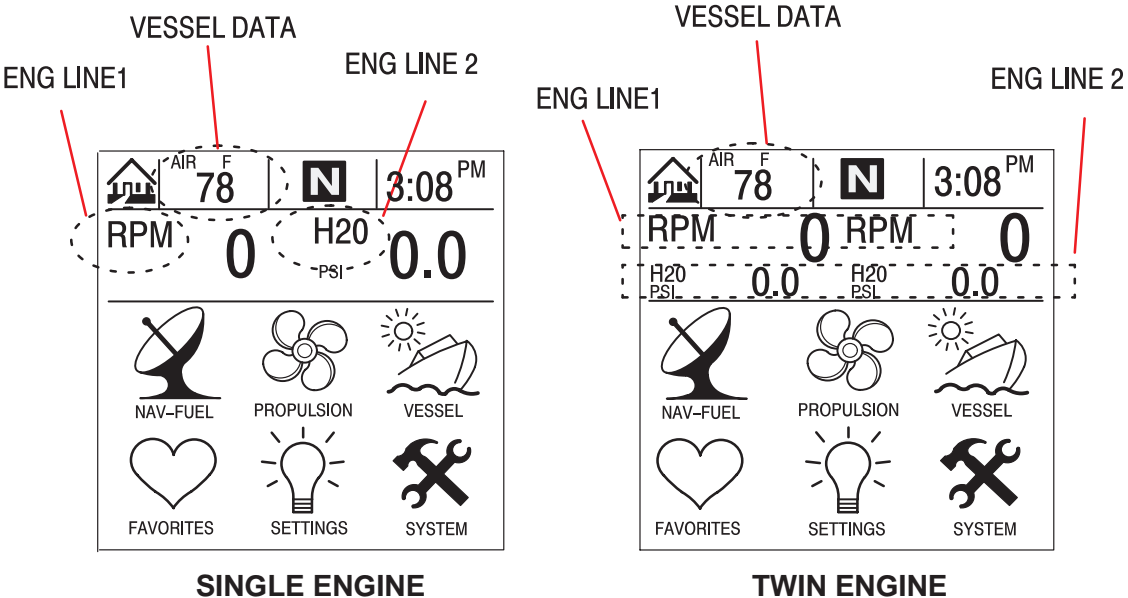
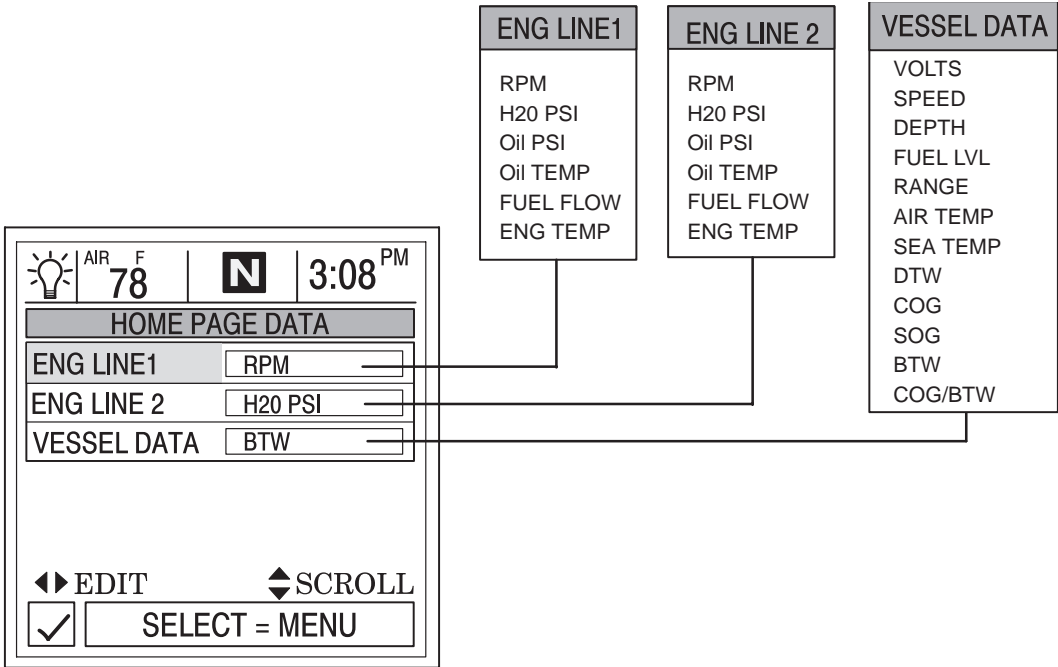

Settings Options

Sensors

To adjust a setting:

1. Press ▲▼ to highlight the desired menu selection.
2. Press ◀▶ to edit the menu box.
3. Press **SELECT** to accept settings.

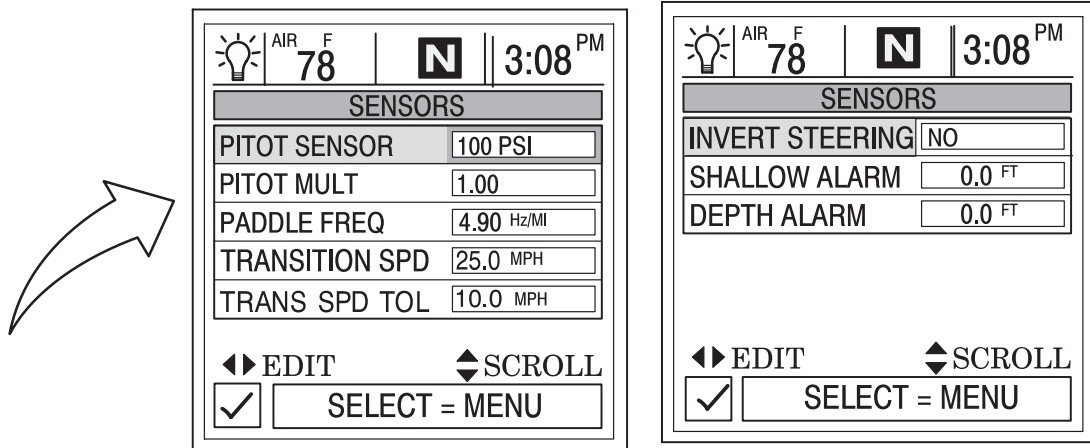

PITOT SENSOR – Select the PSI input of the Pitot water pressure sensor on the engine.

NOTE: The standard speed input on production Mercury engines is 100 PSI. Certain High Performance applications may require a 200 Psi input.

PITOT MULT (Multiplier) – The pitot pressure sensor can be calibrated for correcting display readings that read to high/low. Calculate the percentage that the speed is off and enter it into the menu window.

PADDLE FREQ – Frequency can be changed to match requirements of different sensors. 4.9 Hz per mile or 5.7 Hz per knot is the frequency of the paddle wheel speed sensor provided by Mercury Marine.

TRANSITION SPD – Transition speed is the boat speed at which System View stops looking at the paddle wheel and starts using the pitot or GPS (GPS is priority for high speed if connected) to measure boat speed. Default setting is 25 MPH. If desired, this transition speed can be changed.

TRANS SPD TOL (Transition Speed Tolerance) – Adjust for differences in sensor tolerances between the paddle wheel, GPS, and pitot. Default setting is 10 MPH.

INVERT STEERING – If steering angle displayed is opposite of the direction that it should, the signal can be inverted so the steering angle can be displayed properly.

SHALLOW ALARM – The shallow water alarm can be set to sound a warning at a depth determined by the user. Activate the shallow water alarm by inputting the desired depth into the menu box. The depth range can be from 0.0 – 650.0 feet. Deactivate the shallow alarm by setting the shallow alarm to “0”. For the alarm to operate, the alert horn setting will have to be activated. Refer to “Setting/Preferences” Menu Section 6

DEPTH ALARM – The deep water alarm can be set to sound a warning at a depth determined by the user. Activate the depth alarm by inputting the desired depth into the menu box. The depth range can be from 0.0 – 650.0 feet. Deactivate the depth alarm by setting the depth alarm to “0”. For the alarm to operate, the alert horn setting will have to be activated. Refer to “Setting/Preferences” Menu Section 6

Settings Options

Preferences

To adjust a setting:

1. Press ▲▼ to highlight the desired menu selection.
2. Press ◀▶ to edit the menu box.
3. Press **SELECT** to accept settings.

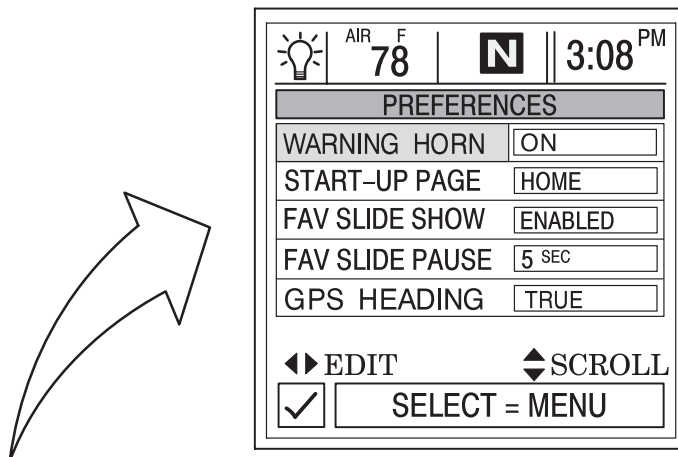

WARNING HORN – The System View has a warning horn alarm. You can set an alarm to sound a warning tone for various fault alarms and shallow or deep water depth warning. To use this alarm, press the right arrow to **ON**.

START-UP PAGE – You have two options for what start-up page you want to view. You can select the home page or you can select the last page that’s showing at power off. Press the right arrow to select **HOME** or **LAST USED**.

FAVORITE SLIDE SHOW – This feature if desired, will automatically scroll through your selection of favorite screens. This allows the user to view each screen for the pause time selected below. Hold **SELECT** button for 3 seconds to pause the scrolling.

FAVORITE SLIDE PAUSE – Select the pause time you would prefer for viewing each favorite screen in the **Favorite Slide Show**. Select between **5** and **30** seconds.

GPS HEADING – Choose **TRUE** or **MAGNETIC** for the GPS Heading display.

NOTE: To receive BTW in both **TRUE** and **MAGNETIC**, System View must see a valid BWC sentence. If System View sees an RMB sentence, System View will display **TRUE** BTW only.

Settings Options

Favorites/Page Status

The favorites/page status allows you to select one of the two following options:

1. Allows you to choose your preferences screens and place them into the **FAVORITES** directory for quick viewing. Screens will still be shown in their respective menus.
2. Allows you to turn off any unwanted screens from all directories in System View.

To adjust a setting:

1. Press ▲▼ to scroll through the list of screens.
2. Press ◀▶ to edit the setting as follows:

♥ Flagging the selected screen with a heart will add the screen to the **FAVORITES** directory. It will also be available in its directory.

✓ Flagging the screen selection with a check mark will turn the screen on in its directory and off in the **FAVORITES** directory.

X Flagging the screen selection with a “X” mark will turn the screen off in its directory and also off in the **FAVORITES** directory.

SYNCHRONIZER

Screen Selections

SYSTEM

Section 7

Table of Contents

System Information	7-2
Entering the System Directory	7-2
System Directory	7-2
System Calibration	7-3
Tank Configuration	7-4
Trim Calibration	7-6
Factory Defaults	7-7
User Keyless Code	7-8
Maintenance Log	7-10
Recording Run Time	7-10
Active Alarms	7-11
Active Alarms	7-11
Alarm History	7-15
Alarm History	7-15

SYSTEM

System Information

This Section will give a complete description of the screen settings in the **SYSTEM** directory of the System View.

Some of the system functions are:

- Maintenance log
- Active alarms
- Alarm history
- System calibration

Entering the System Directory

To access the **SYSTEM** directory, use the trackpad to highlight the **SYSTEM** directory from the menu choice. Press **SELECT** to accept and to open the directory.

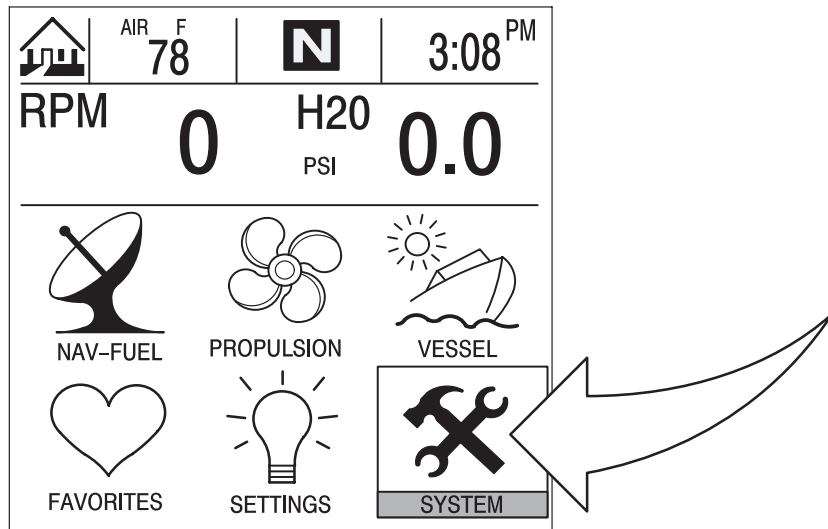

System Directory

System Directory Screen

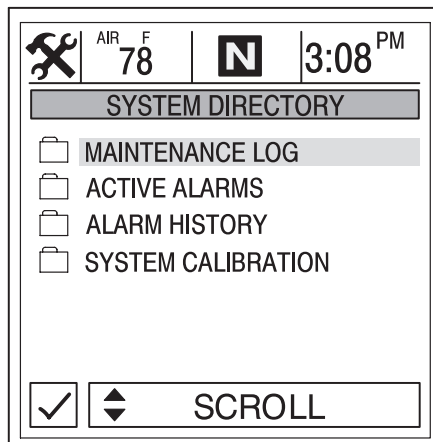

System Calibration

System Calibration

The system calibration consists of the following menus:

- Tank configuration
- Trim calibration
- Factory defaults
- User keyless code

Entering into System Calibration

IMPORTANT: Entering into the system calibration menus will require you to shut down the engine(s) in order to reactivate the System View.

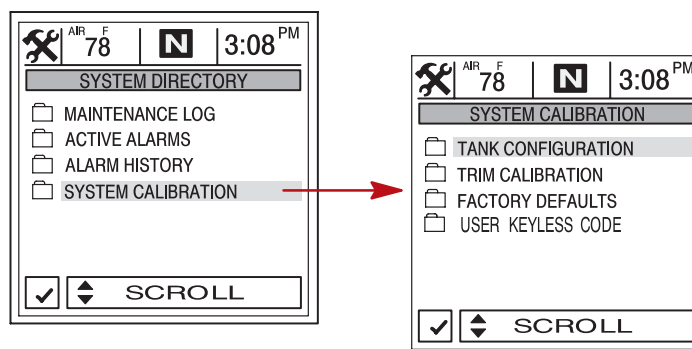

System Calibration

Tank Configuration

NOTE: System View allows you to choose the name of the tanks you want to appear on the screen. You can choose two tanks per engine.

1. Choose the names of the tank(s), that you would like to appear on screen. highlight the tank you would like to change. Press ◀▶ to display the list of names of available tank types. Select a name. Press **SELECT** to continue.
2. Enter the capacity of the tanks. Select the tank and press ◀▶ to enter the tank capacity. Press **SELECT** to continue.

TANK CONFIGURATION

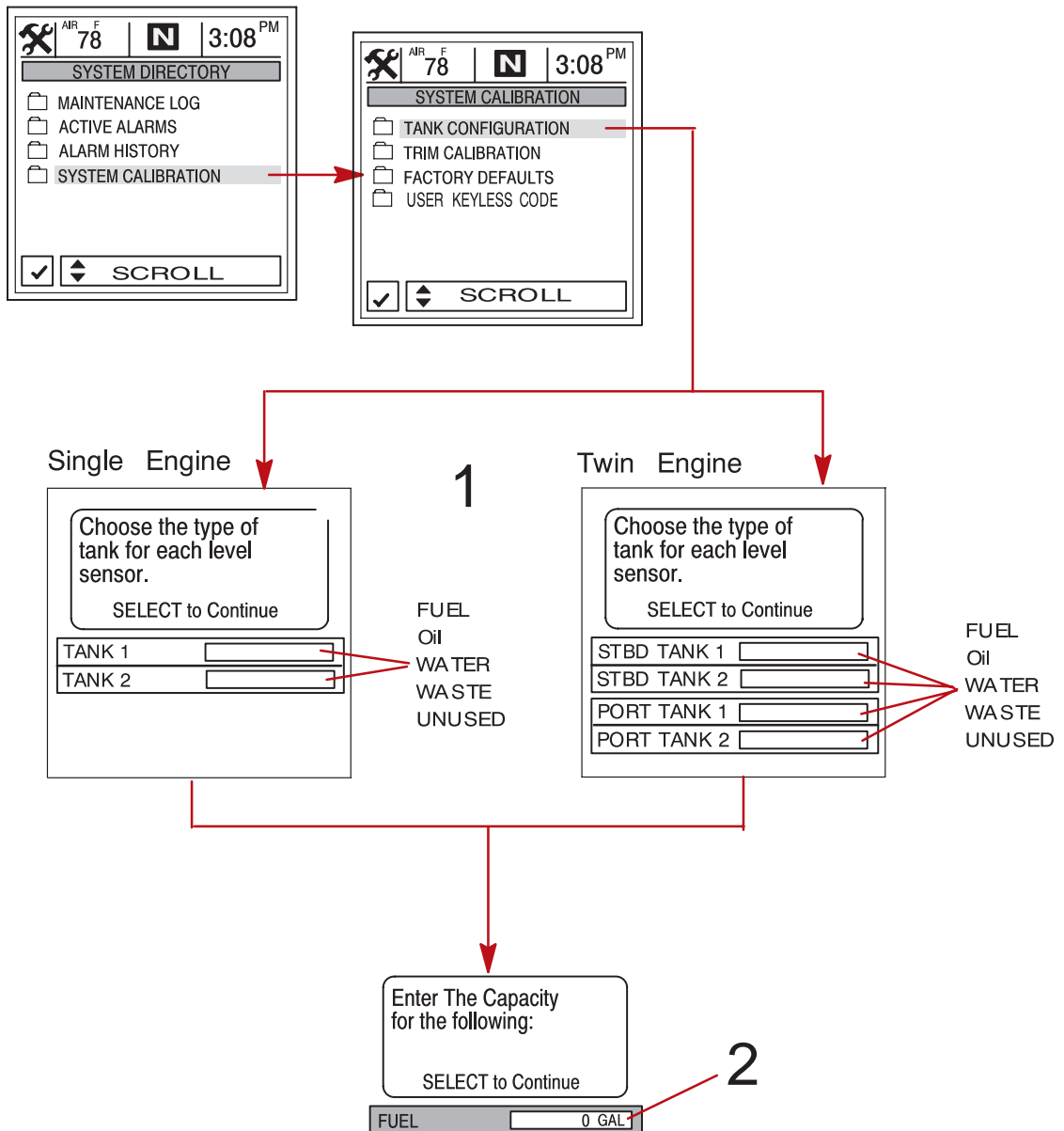

System Calibration

Tank Configuration (Continued)

NOTE: The fuel tank will have to be calibrated in order for System View to display fuel range.

3. There are two methods for calibrating fuel tank level:
 - a. **Method 1** – Select **DEFAULT** – The System View will automatically supply an estimated range value based on default sensor values. This mode does not factor in irregular tank shapes. Press **SELECT** to save.
 - b. **Method 2** – Select **ADD FUEL** – This method requires adding fuel at certain calibration points. System View will display an estimated range value that factors in the tank shape.

NOTE: You will have to start with an empty fuel tank and manually fill the tank to the values given per instruction.

4. If using **Method 2**, add fuel as shown in illustration below.

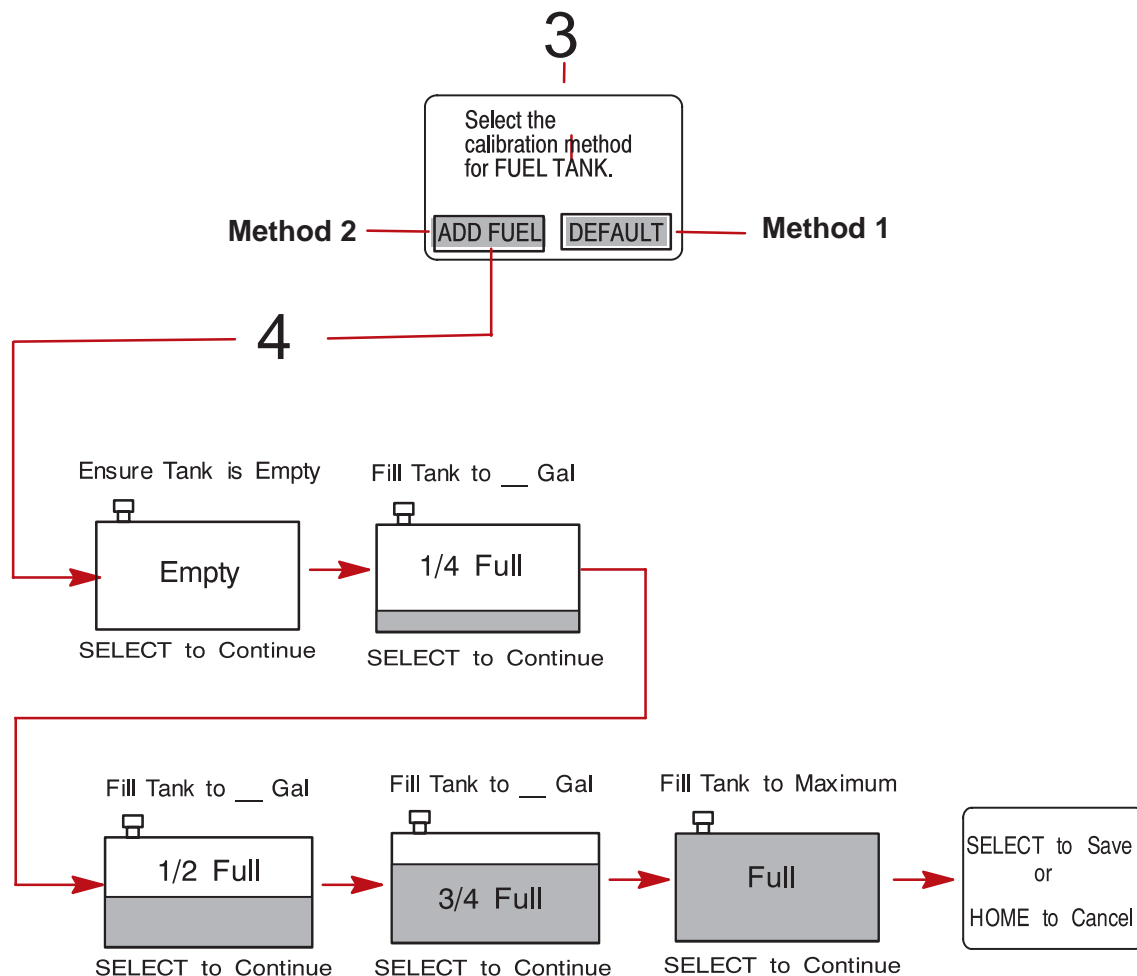

Trim Calibration

CALIBRATING THE TRIM SENSOR

To calibrate trim:

1. Open the **TRIM CALIBRATION** menu.
2. **TRIM ENG DOWN:** Press the **SELECT** key to open the **DOWN** screen. Trim the engine all the way down. Press **SELECT** to save and move to next screen.
3. **TRIM ENG UP:** The **TRIM ENG UP** screen should be open. Trim the engine all the way up. Press **SELECT** to save and move to next screen.
4. **TRIM ENG MAX TRAILER:** the **TRIM ENG MAX TRAILER** screen should be open. Trim the engine to maximum trailer position. Press **SELECT** to save.

NOTE: If trim calibration is correct, trim range should be displayed in units from 0.0 to 10.0 and 10.1 to 25.0 will correspond to the trailer range.

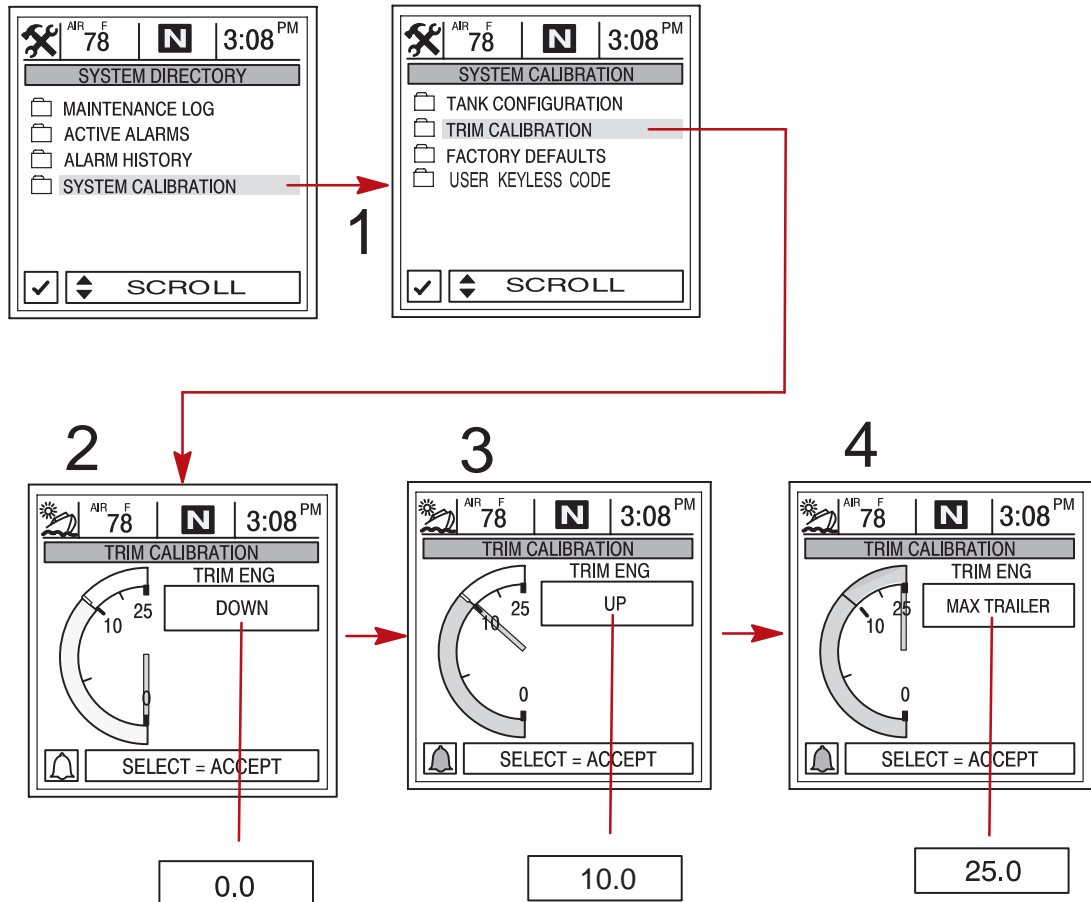

System Calibration

Factory Defaults

RESET SETTINGS DIRECTORY

Restores all settings back to System View's original setup values.

To restore settings back to original setup values:

1. Open **FACTORY DEFAULTS** menu.
2. Press ▲▼ to highlight **RESET SETTINGS DIRECTORY** selection.
3. Select **YES** to reset or **NO** if you want to cancel.

RESET SENSOR DETECTION

At first power up, the System View will automatically detect all the sensors connected to it. If you would like the System View to re-start this sensor detection process over again, use the following procedure.

To reset sensor detection:

4. Open **FACTORY DEFAULTS** menu.
5. Press ▲▼ to highlight **RESET SENSOR DETECTION** selection.
6. Select **YES** to reset or **NO** if you want to cancel.

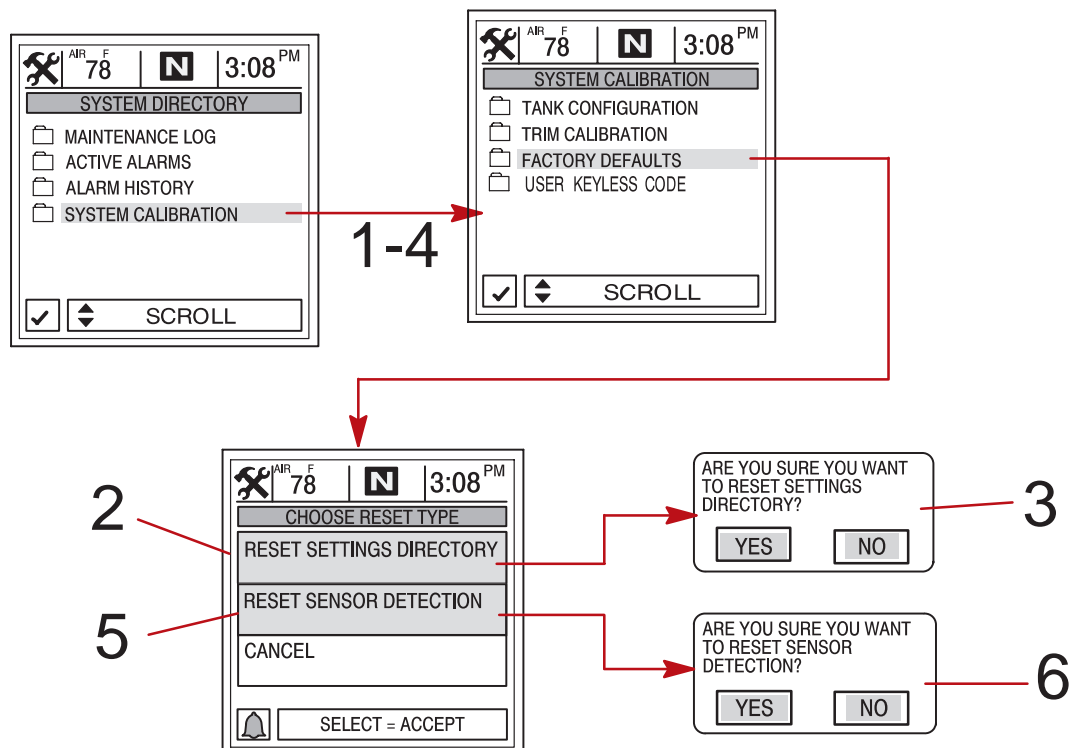

System Calibration

User Keyless Code

A keyless code can be set to prevent unintentional power-up of the System View when using the **HOME** (Power) button. Once a keyless code has been set, the System View will require the code number to be entered when powering-up the System View using the **HOME** (Power) button.

NOTE: If you would like to set a security blind to keep others from viewing your on-screen code entry, press **HOME** button momentary after viewing the keyless entry screen during power up. This will change the code entries to (+) symbols and will allow you to enter your keyless code without viewing the digits.

CREATING (FIRST TIME) KEYLESS CODE NUMBER

1. Power up the System View using the **HOME** button.
2. Open the System View directories to access the **USER KEYLESS CODE** menu.
3. Enter 4 zero's (**0000**) in the first menu box as follows:
 - a. Press ◀▶ to move the highlight box to each digit.
 - b. Press ▲▼ to select each digit.
 - c. After entering the 4 zero's (0000), Press **SELECT** to continue.
4. Select a permanent 4 digit key code number and enter that number in the second menu box. Press **SELECT** key. This confirms the key code number.

TURNING OFF KEYLESS CODE NUMBER

Entering 4 zero's (**0000**) in the **ENTER NEW KEY CODE** box will turn off the Keyless Code number screen.

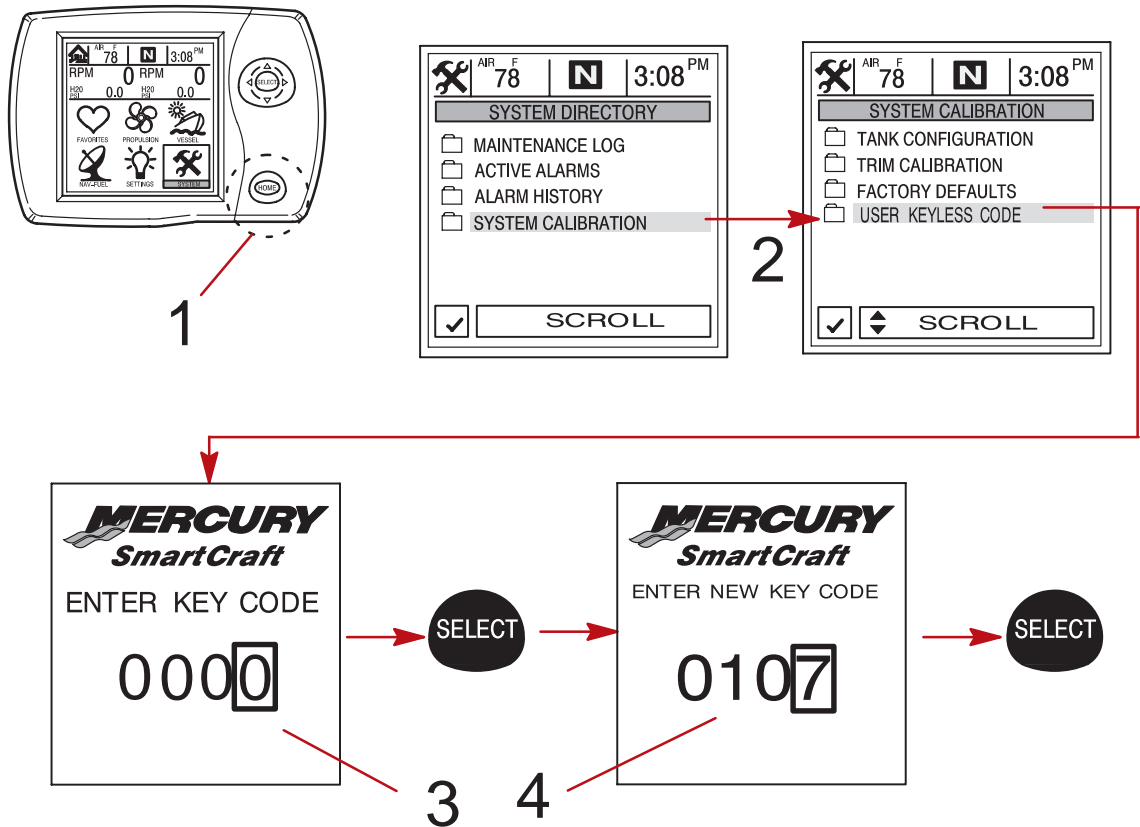

System Calibration

User Keyless Code

CHANGING YOUR KEYLESS CODE NUMBER

1. Power up the System View using the **HOME** button.
2. Open the System View directories to access the **USER KEYLESS CODE** menu.
3. Enter your existing 4 digit key code number in the first menu box as follows:
 - a. Press ◀▶ to move the highlight box to each digit.
 - b. Press ▲▼ to select each digit.
 - c. After entering the 4 digit number, press **SELECT** to continue.
4. Select a new 4 digit key code number and enter that number in the second menu box. Press **SELECT** key. This confirms the new key code number.

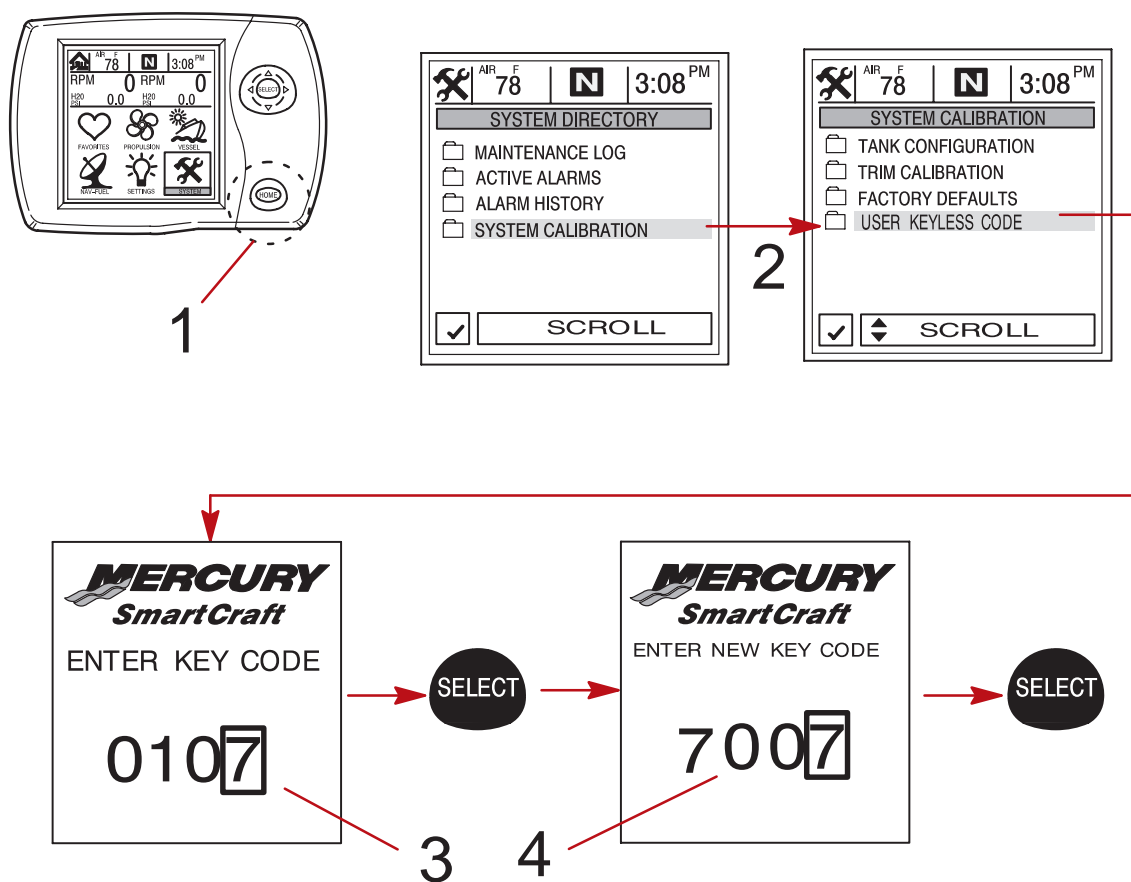

Maintenance Log

Maintenance Log

RECORDING RUN TIME

The maintenance log allows you to record the current engine run time at each service interval. Service intervals should be performed at the time periods specified in your *Engine Operation, Maintenance Manual*.

Recording engine run time at maintenance intervals:

1. Open the **MAINTENANCE LOG** directory.
2. Use the trackpad to select the desired **RUN-TIME** interval box. The engine run time in the box you selected will be blinking. If this is the desired interval you want to record current engine run time, press **SELECT** to save. If you are trying to overwrite a previously recorded interval, you will be asked to confirm your intent.

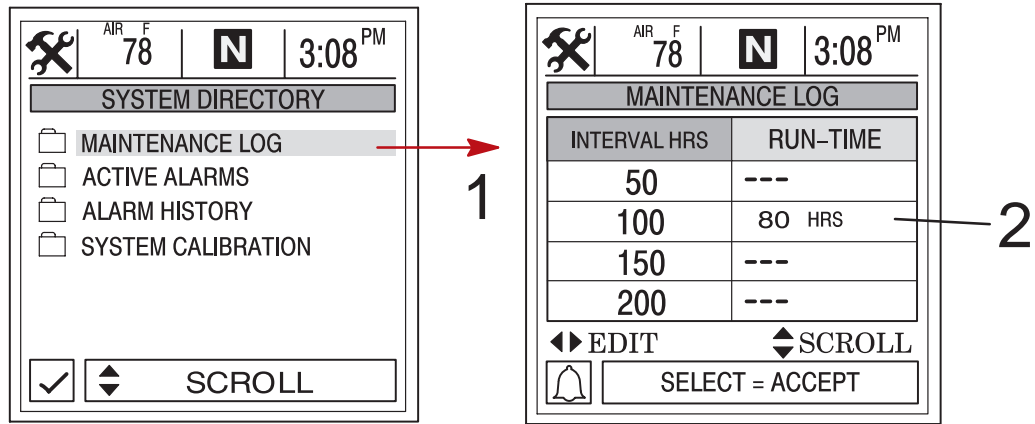

Active Alarms

Active Alarms

The **ACTIVE ALARMS** screen displays all active alarms. The active alarm message will alert the operator to the potential problem.

When a problem is detected with the system, the System View will alert the operator to the potential problem by displaying the alarm data in the information window, located at the bottom of the view screen. Refer to the *Engine Operation, Maintenance Manual* for explanation of the problem and the correct action to take.

If problem can cause immediate engine damage, the Engine Guardian System will respond to the problem by limiting engine power. Immediately reduce throttle speed to idle. Refer to the *Engine Operation, Maintenance Manual* or alarm messages following, for further explanation of the problem and the correct action to take.

To view active alarms:

1. Open the **ACTIVE ALARMS** directory. The directory will displays all active alarms.

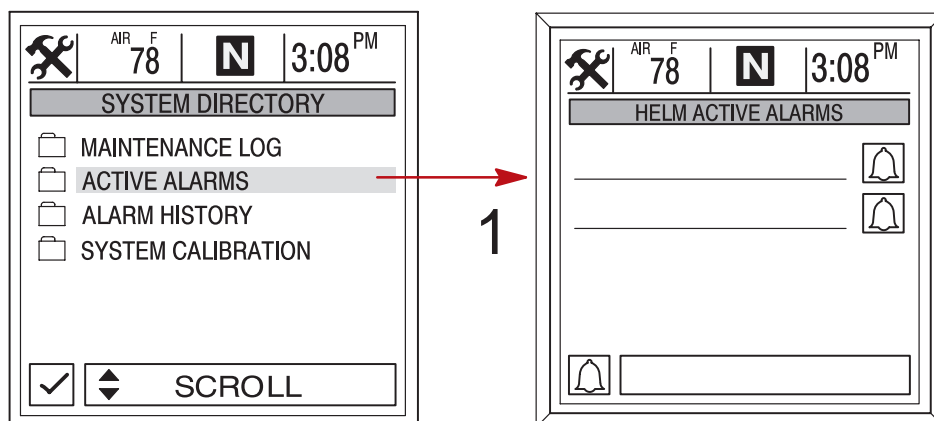

Helm Active Alarms

NOTE: Not all active alarms listed may be available for your type of engine.

Alarm Message (Pop-Up Screen)	Helm Active Alarm	Description
PUMP ALARM	OIL PUMP OUTPUT	The oil pump has stopped functioning electrically (2-cycle outboards). No lubricating oil is being supplied to the engine.
INJECTOR ALARM	DINJ 1-6 OPEN/SHORT FINJ 1-6 OPEN/SHORT	Engine problem occurred. Have the engine checked by your dealer.
SENSOR ALARM	<i>Active alarm will display the sensor that is at fault</i>	Engine problem occurred. Have the engine checked by your dealer.
IGNITION ALARM	<i>Active alarm will display the ignition component that is at fault</i>	Engine problem occurred. Have the engine checked by your dealer.

SYSTEM

Active Alarms

Helm Active Alarms

Alarm Message (Pop-Up Screen)	Active Alarm	Description
SYSTEM ALARM	PORT HEAD OVRHT STBD HEAD OVRHT COMPRESS OVRHT	The engine has overheated. Refer to the <i>Engine Operation and Maintenance Manual</i> for information on overheating.
	BATTERY VOLT HI	Battery voltage is above the allowable limit. Have the electrical system checked by your dealer.
	BATTERY VOLT LO	Battery voltage is below the allowable limit. Have the electrical system checked by your dealer.
	BLOCK PRESSURE IS LOW	The water pressure in the engine is low. Failed water pump. Check for blockage at the water intake holes in the gear case. Have the engine checked by your dealer.
	ESC-NS POS DIFF ESC-ERC POS DIFF ESC TIMEOUT	Electronic remote control circuit problem. Have the system checked by your dealer.
	ESC CONTROL LOST	Electronic remote control problem occurred. Have the system checked by your dealer.
	ETC CONTROL ETC STICKING	Engine problem occurred. Have the engine checked by your dealer.
	FUEL LVL CKT HI/LO	Fuel level circuit problem. Have the system checked by your dealer.
	FUEL PUMP RLY CKT	Fuel pump problem. Have the system checked by your dealer.
	HORN OUTPUT	Warning horn is not functioning correctly. Have the system checked by your dealer.
	IAC OUTPUT	Idle air control is not functioning correctly. Have the system checked by your dealer.
	LOW DRIVE LUBE	Drive lube low or faulty low lube switch.
	MAP IDLE ERR	MAP sensor is not functioning correctly. Have the engine checked by your dealer.
	OIL LVL CKT HI/LO	Oil level circuit problem. Have the system checked by your dealer.

Active Alarms

Helm Active Alarms

Alarm Message (Pop-Up Screen)	Active Alarm	Description
SYSTEM ALARM	PITOT CKT HI/LO	Pitot sensor circuit problem. Have the system checked by your dealer.
	PRT COOL OVRHT	The engine has overheated. Refer to the <i>Engine Operation and Maintenance Manual</i> for information on overheating.
	PWR RELAY OUTPUT/BACKFD	Main power relay is not functioning correctly. Have the engine checked by your dealer.
	SEA TEMP CKT HI/LO	Boat mounted water temperature sensor circuit problem. Have the system checked by your dealer.
	SHIFT POS CKT HI/LO	Shift position sensor circuit problem. Have the system checked by your dealer.
	START SOLENOID	Start solenoid circuit problem. Have the system checked by your dealer.
	TPI ALL ERR TPI _ DIFF ERR	Throttle position sensor circuit problem. Have the system checked by your dealer.
	TRIM CKT HI/LO	Power trim sensor circuit problem. Have the system checked by your dealer.
	THERMOSTAT FAULT	Failure to reach engine operating temperature. Have the engine checked by your dealer.
	WATER IN FUEL	Water in the engine water-separating fuel filter reached the full level. Water can be removed from the filter. Refer to the <i>Engine Operation and Maintenance Manual.0</i>
5 VDC PWR LO	Sensor circuit problem. Have the system checked by your dealer.	
SWITCH ACTIVITY	OIL LVL ENG LO	Oil level is critically low in the engine mounted oil reservoir tank (2-cycle engines). The engine mounted oil reservoir tank along with the remote oil tank will have to be refilled. Refer to the <i>Engine Operation and Maintenance Manual</i> .

Active Alarms

Helm Active Alarms

Alarm Message (Pop-Up Screen)	Active Alarm	Description
ENGINE POWER LIMITED	ECT OVRHT	Water temperature in engine is too hot. Cooling problem. Have the engine checked by your dealer.
	GUARDIAN	Guardian is trying to protect the engine by reducing engine speed.
	MAP DIFF ERR MAP INPUT HI/LO	MAP sensor is not functioning correctly. Have the engine checked by your dealer.
	NEUTRAL OVERSPEED	Recommended engine overspeed in neutral has been exceeded.
	OVERSPEED	Recommended engine RPM range has been exceeded.
	PORT EMCT OVRHT	Port exhaust manifold is overheating. Cooling problem. Have the engine checked by your dealer.
	REVERSE OVERSPEED	Recommended engine overspeed in reverse has been exceeded.
	STB EMCT OVRHT	Starboard exhaust manifold is overheating. Cooling problem. Have the engine checked by your dealer.
LOST COMMUNICATION TO THE ENGINE	STBD MED SPD DATA LOST STBD BACKUP ETCESC DATA STSD ETCESC DATA LOST STBD LOW SPD DATA LOST DUAL CAN ERR	System View does not see the engine computer. Usually indicates that no data is being transferred from the engine's computer to System View. Check wiring, also make sure both terminator resistors are installed in the bus.
DTS MODULE ALARM & SYSTEM ALARM	PRIMARY CTRL SOH CROSSCHECK SOH	Problem in the SmartCraft wiring system
COMMUNICATION LOST TO ENGINE & DTS MODULE ALARM	STBD MED SPD DATA LOST STBD LOW SPD DATA LOST	Problem in the SmartCraft wiring system

Alarm History

Alarm History

The **ALARM HISTORY** displays all alarms that are, or have been active since last engine key-up.

To view alarm history:

1. Open the **ALARM HISTORY** directory. The directory will display alarm history.

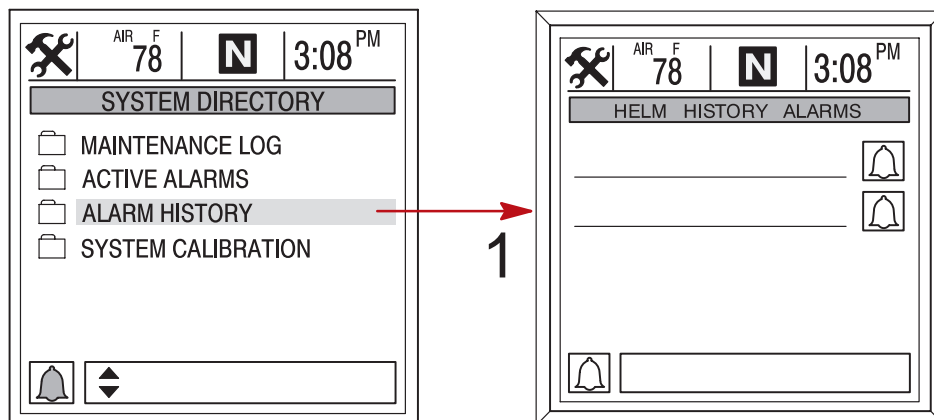

INSTALLATION

Section 8

Table of Contents

Components	8-2
Special Information	8-2
Installation Information	8-2
System View Installation	8-3
Wiring	8-4
Connecting Optional GPS Unit to the System View	8-7
Setup for Multi Engine Location	8-7

SYSTEM VIEW INSTALLATION

Components :

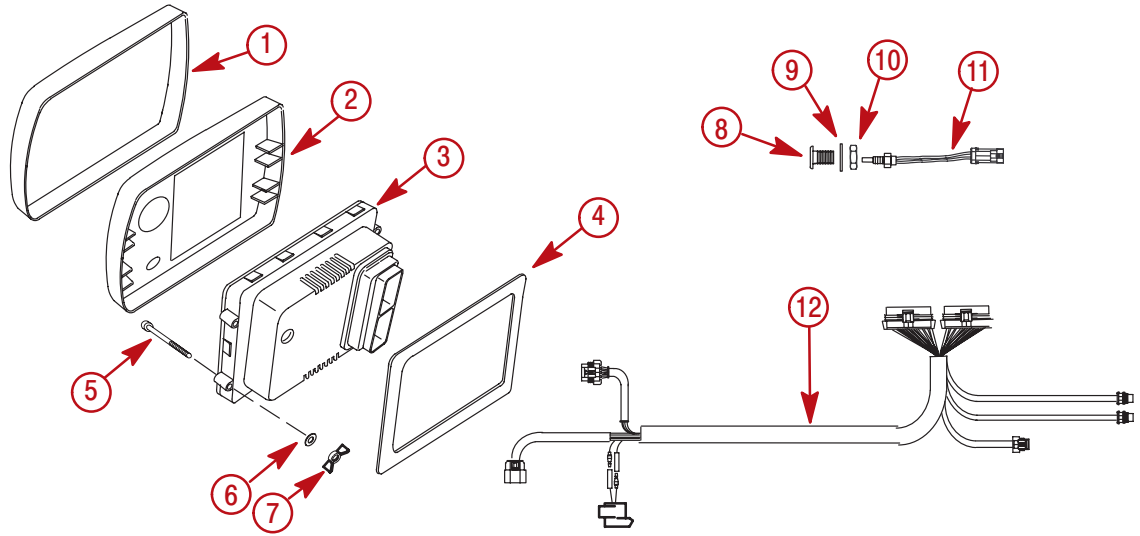

REF.	QTY.	DESCRIPTION	PART NUMBER
1	1	Cover	879948T04
2	1	Bezel	879947T03
3	1	System View with seal	79-888923K05
4	1	Seal	NSS
5	4	Screw	10-66687
6	4	Flat washer	12-56681
7	4	Wing nut	11-816874
8	1	Mounting adaptor	859021
9	1	Washer	12-859029
10	1	Nut	11-859022
11	1	Temperature sensor	885342001
12	1	SmartCraft harness	84-882755T02

Special Instructions

Clean lens with water only.

Installation Information

⚠ WARNING

Disconnect both battery cables at battery before attempting to install gauges

Before cutting any holes, check area behind dashboard for obstructions (braces, cables, wiring, etc.)

CUTTING TIPS

Fiberglass – Apply masking tape to area to be cut to prevent dashboard from cracking.

Vinyl Covered – Remove vinyl from area to be cut with razor blade to keep vinyl from tearing.

System View Installation

- 1. Select a location for the System View that affords good visibility and accessibility from behind dashboard.
- 2. Cut out mounting hole to the given dimensions.

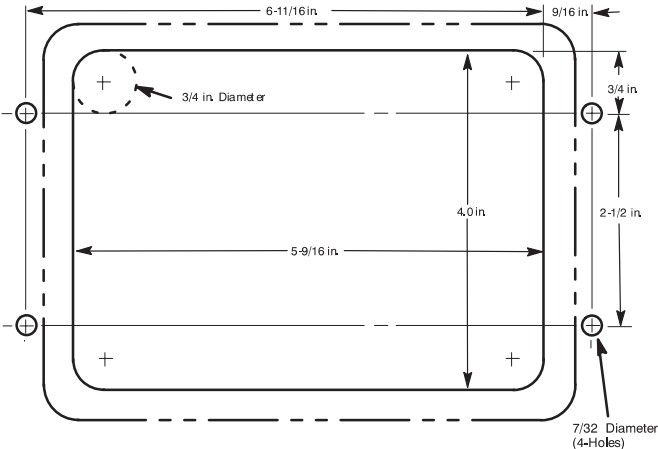

Metric Conversion

7/32	=	5 mm
1/2	=	12.7 mm
9/16	=	14.4 mm
3/4	=	19.0 mm
2-1/2	=	63.5 mm
4.0	=	101.6 mm
5-9/16	=	141.2 mm
6-11/16	=	169.67 mm

- 3. Place System View along with seal into dashboard and secure with 4 screws.

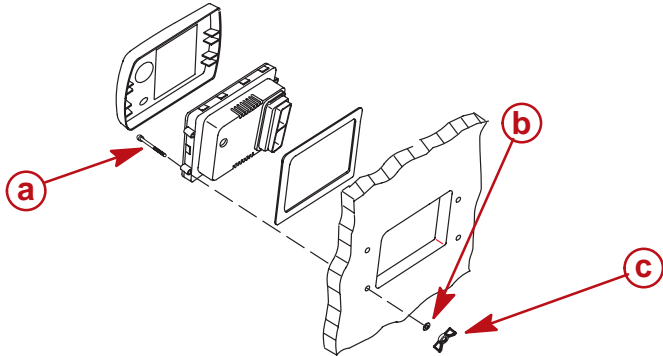

- a** - Screw (4)
- b** - Flat washer (4)
- c** - Wing nut (4)

- 4. Install the outside air temperature sensor as follows:
 - a. Mount the sensor where it will be exposed to outside air and will not be in direct sunlight.
 - b. Select a location and drill a 3/4 in. (19.0 mm) mounting hole.
 - c. Install the mounting adaptor as shown.
 - d. Thread the air temperature sensor into the mounting adaptor.

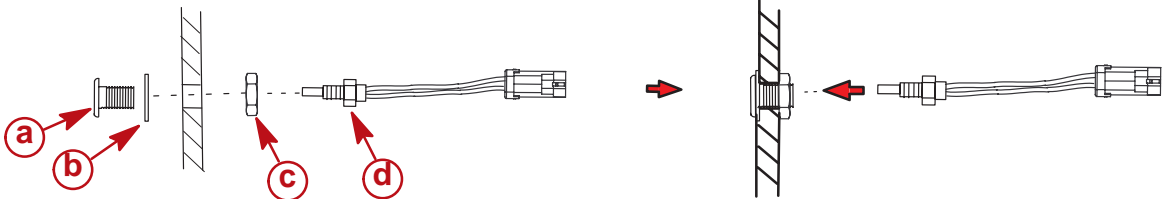

- a** - Mounting Adaptor
- b** - Gasket
- c** - Nylon Nut
- d** - Air Temperature Sensor

INSTALLATION

Wiring

MODELS WITHOUT ELECTRONIC THROTTLE/SHIFT

NOTE: Extension Wiring Harnesses for the System Link gauges are available in 3 ft, 10 ft and 30 ft lengths. (84-880756b-3,10,30)

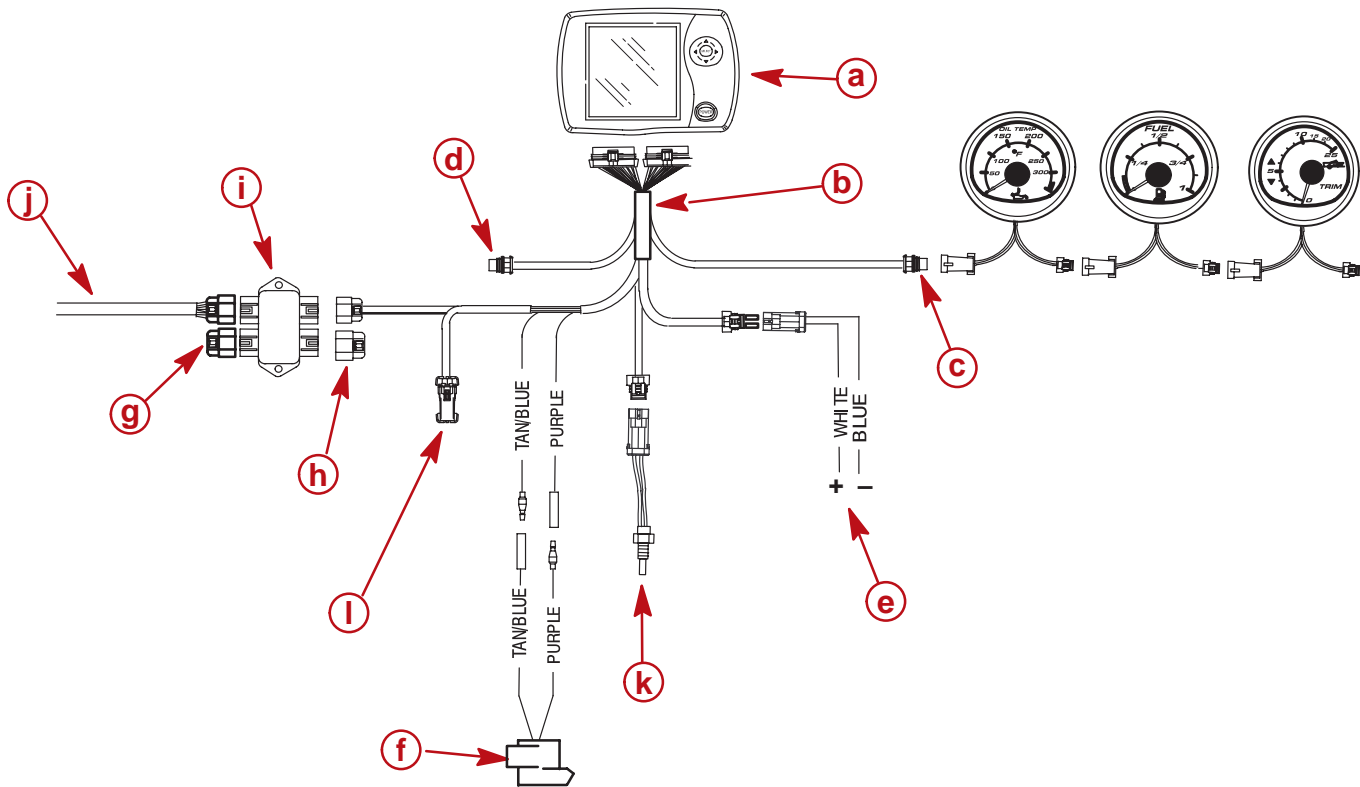

- a** - System view
- b** - Display harness
- c** - System link gauge connection – (starboard)
- d** - System link gauge connection – (port)
- e** - GPS (Optional) connection
- f** - Horn – (provided with display harness)
- g** - Terminator
- h** - Weather cover
- i** - Junction box
- j** - SC data cable – (from engine)
- k** - Air temperature sensor – (provided with display harness)
- l** - Not used (seal connection with weather cap)

Wiring

ELECTRONIC THROTTLE/SHIFT MODELS – SINGLE ENGINE

NOTE: Extension Wiring Harnesses for the System Link gauges are available in 3 ft, 10 ft and 30 ft lengths. (84-880756b-3,10,30)

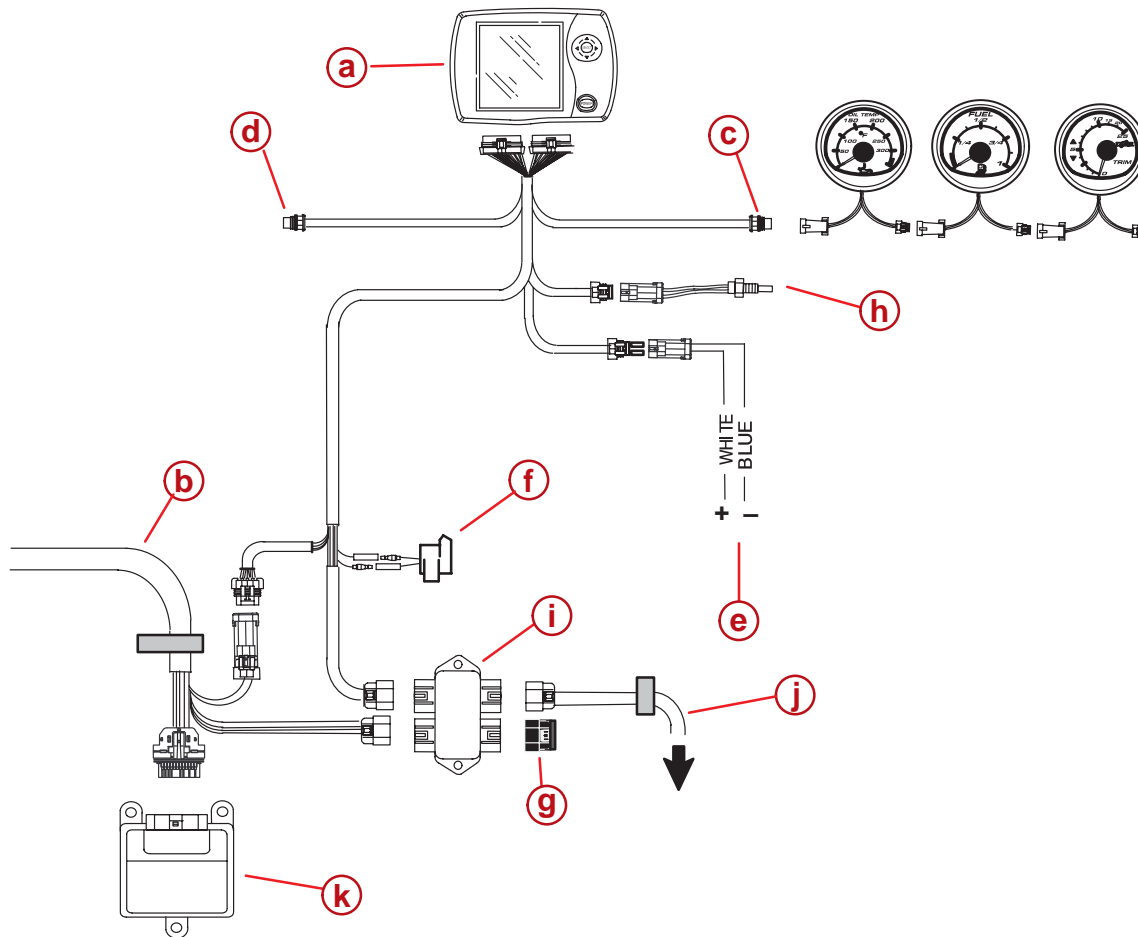

- a** - System view
- b** - DTS Command Module harness
- c** - System link gauge connection – (starboard)
- d** - System link gauge connection – (port)
- e** - GPS (Optional) connection
- f** - Horn – (provided with display harness)
- g** - Terminator
- h** - Air temperature sensor
- i** - Junction box
- j** - SC data cable – (from engine)
- k** - DTS Command Module

INSTALLATION

Wiring

ELECTRONIC THROTTLE/SHIFT MODELS – TWIN ENGINES

NOTE: Extension Wiring Harnesses for the System Link gauges are available in 3 ft, 10 ft and 30 ft lengths. (84-880756b-3,10,30)

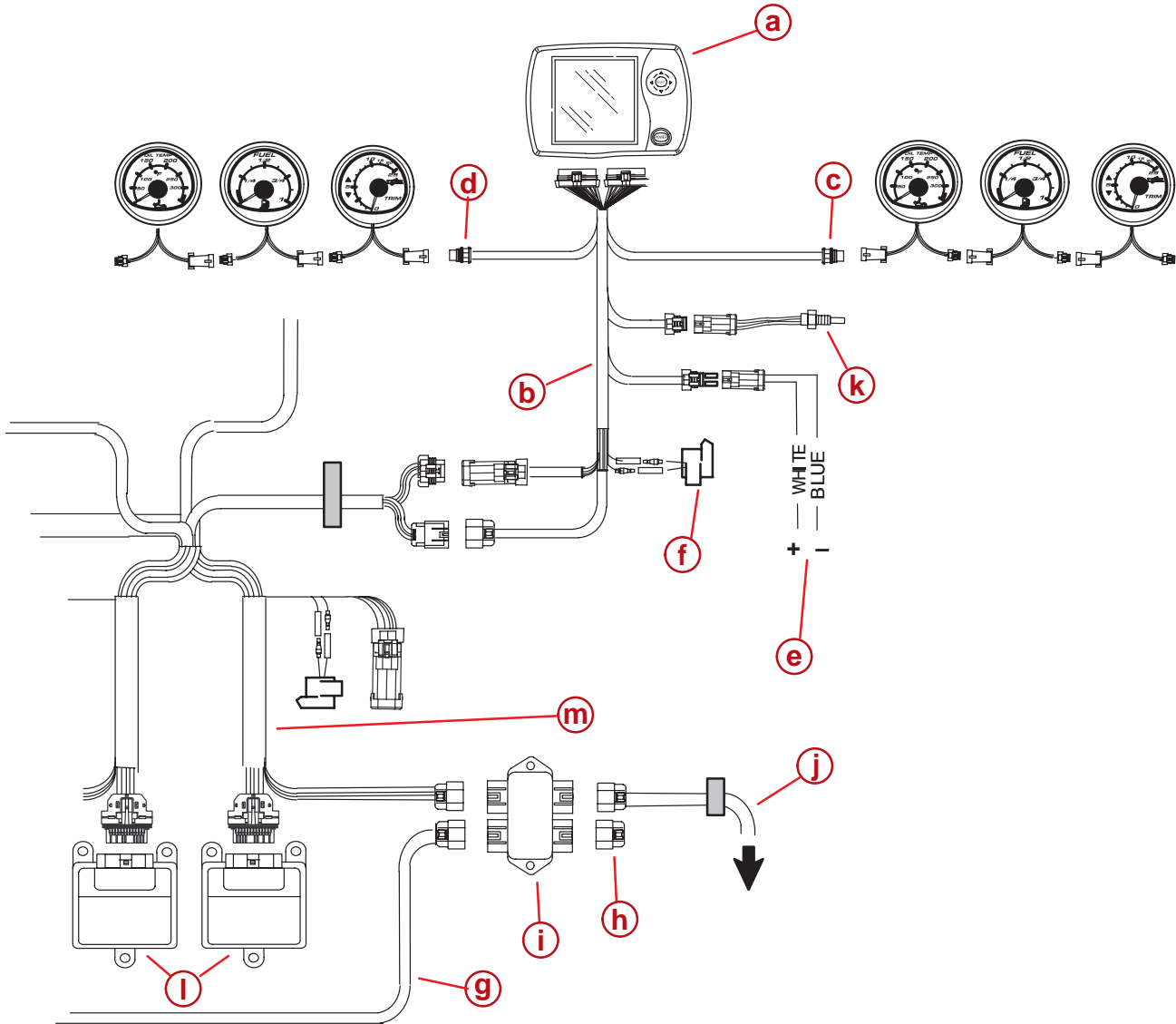

- a** - System view
- b** - Display harness
- c** - System link gauge connection – (starboard)
- d** - System link gauge connection – (port)
- e** - GPS (Optional) connection
- f** - Horn – (provided with display harness)
- g** - Link harness
- h** - Weather cover
- i** - Junction box
- j** - SC data cable – (from starboard engine)
- k** - Air temperature sensor – (provided with display harness)
- l** - DTS Command Module
- m** - DTS Command Module Harness

Connecting Optional GPS Unit to the System View

NOTE: *The GPS unit must comply to the National Marine Electronic Association NMEA 0183 Interface Standard v1.5, v2.0 or later compatible version.*

First, look at the GPS wiring diagram and determine what two leads are the GPS output leads. Locate the White and Blue wires coming from the System View wiring harness (see Wiring). Connect the GPS output leads to the white and blue wires. If no data is received, switch the wire connections around. If no data is still received, refer the GPS owner's manual and see if the GPS has to be calibrated to turn on the output signal or needs to be grounded differently.

Setup for Multi Engine Location

In multiple engine applications, each engine must be assigned a location. For example, starboard and port. This is required for the correct engine data to be transmitted to the System View. If the System View should ever detect an incorrect engine location, it will alert you by displaying a multi engine fault message. If this should happen, reset the engine locations using the Quicksilver Digital Diagnostic Terminal (DDT) along with SmartCraft Engine Diagnostic Cartridge Version 1.0 or newer.

INDEX

Section 9

A		H	
Alarms– Active	7-11	Home Page Data	6-5
Air Temperature	5-6	Home Page Screens	2-3
Alarm History	7-15	I	
Alarm Message Screens	2-9	Installation	8-3
B		Invert Steering	6-6
Boat Speed	5-6	K	
Brightness	6-3	Keyless Code	7-8
C		Keypad Usage	1-2
Clock Settings	6-3	L	
Connecting GPS Unit to the System View	8-7	Language	6-4
Contrast	6-3	M	
D		Maintenance Log	7-10
Data Display Screen	2-5	N	
Depth	5-5	Navigation Screens	5-3
Depth Alarm	6-6	Navigation/Fuel Directory	5-2
Depth Offset	6-4	Next Waypoint Data	5-4
Depth Plot Line	5-5	P	
Display Screens	2-2	Paddle Frequency	6-6
E		Peak Speed at RPM	3-3
Engine Data Screens	3-4	Pilot Multiplier	6-6
Engine RPM Synchronizer	3-4	Pilot Sensor	6-6
Engine RPM/Speed	3-3	Preference Settings	6-7
Environment	5-6	Propulsion Directory	3-2
F		R	
Favorite Page Screen Selection	6-8	Resetting Sensor Detection	7-7
Favorite Page Status	6-8	Restoring Factory Settings	7-7
Favorite Slide Pause Setting	6-7	S	
Favorite Slide Show Option	6-7	Seawater Temperature Offset	6-4
Fuel Flow	5-7	Seawater Temperature Plot	5-6
Fuel Range	5-7	Sensors	6-6
Fuel Remaining	5-7	Setting Directory	6-2
Fuel Tanks	4-4	Settings Information	6-2
G		Setup for Engine Location	8-7
GPS Heading Selection	6-7	Shallow Alarm	6-6

INDEX

Start-up Page Preference	6-7
Start-up Screens	2-2
Starting Up the System View	2-2
Steering Offset	6-4
Steering Position	4-3
System Calibration	7-3
System Directory	7-2
System Information	7-2

T

Tank Configuration	7-4
Tank Status	4-3
Time Settings	6-3
Transition Speed	6-6
Trim Calibration	7-6
Trim Position	3-5
Trip History Log	5-4
Troll Control	3-6
Turning Off Troll Control	3-6
Troll Control Setting	3-6

U

Units (English or Metric)	6-4
---------------------------------	-----

V

Vessel Course	5-3
Vessel Directory,	4-2
Vessel Status	4-5

W

Warning Horn	6-7
Water and Waste Tanks	4-4
Water Temperature	5-6
Wiring	8-4